



The Bud Light Summer Stimmy

DECLARED AT A BAR

*In the City of Washington on Tuesday, the twenty-seventh day of
April, two thousand and twenty-one*

A Proposal

To provide an awesome amount of awesome ways
to make Summer 2021 even awesomer
for people across America.

*This Proposal should be cited as ‘**The Stimmy**’ and is pursuant to the oath made by the Representatives of Bud Light of St. Louis, Missouri to support all persons ages 21+ in their pursuit of life, liberty, and FUN.*

(I.) From sea to shining sea.

(II.) From every watering hole to every water park.

(III.) From this day forth until Labor Day!

*(IV.) Any person compelled to dance by this announcement is legally obligated to post said dance with **#BudLightStimmyShimmy**.*

B.L. 1982—2

The TABLE OF CONTENTS for this Proposal is as follows:

PART I—GRATIS* SPORTS TICKETS
(the term “gratis” means FREE)

**Tranquilos, no es español. Es Latín.*

Subtitle A—Tons of Tix

Sec. 1 Free Sports Tix!

Subtitle B—More Awesomeness

Sec. 2 Gronk
 Sec. 3 Old-Timey Bicycle And Bathing Costume Home Run
 Sec. 3.14 No Math This Summer!
 Sec. 4 Mt. Rushmore: The Water Park
 Sec. 5-87TE The Secretary Of Summer
 Sec. 6 Hybrid Sports
 Sec. 7.3 Fourth Of July Eve
 Sec. 7 38 Slightly Askew Hats
 Sec. 8 Conga Lines
 Sec. 9.5SZ Boat Shoes
 Sec. 10 Tiny Bathing Suits
 Sec. 11 Tiny And Not So Tiny Umbrellas
 Sec. 12 Favorite Way To Cool Down
 Sec. 13-SH8DS Sunglasses Support
 Sec. 14 Summer Tuesdays
 Sec. 15 Out-Of-Office Auto Replies
 Sec. 16 A Note From The House Sitter
 Sec. 17 World Turtle Day, National Fried Clam Day, Gorgeous Grandma Day (Or... “Summer Holidays”)
 Sec. 20 Bud Light University
 Sección 21 On Piraguas
 Sec. 22-HNG10 Surfboard Construction
 Sec. 23 Rainbows & Rom-Coms
 Sec. 24J-SKI Jet Ski Face
 Sec. 25 Short Pants

PART II—GRATIS BEER

(the term “gratis” means...WAIT, didn't you read PART I? It means ON THE HOUSE)

Subtitle A—The First One Is on Us

Sec. 26 Hear! Hear! Beer! Beer!

Subtitle B—More “More Awesomeness”

Sec. 27 July 79th
 Sec. 28 Statue Of Liberty Summer Appropriate Clothing
 Sec. 29 Mandals
 Sec. 30-SPF Sun Protection
 Sec. 31-K9 Dogs In Sunglasses
 Sec. 33-WEEEEEE Waterslide Exclamations
 Sec. 34-36W Jorts
 Sec. 37-TNT Suggested Things To Blow Up In Summer Blockbusters
 Sec. 38 Mime Memes
 Sec. 39 Man Child(s)
 Sec. 40 Best & Worst Things To Do If You Get Stung By A Bee
 Sec. 41 Approved Father's Day Topics
 Sec. 42-STL Residents Named Louis Or Louise
 Sec. 43 Puppies!
 Sec. 44 Cologne Summer Air Advisory
 Sec. 45 Summer Blockbuster Suggestions
 Sec. 46W Welcome To Bud Light, NJ
 Sec. 47 Beer Buckets
 Sec. 48 Hot Enough For Ya?
 Sec. 49 Summer Blockbuster Suggestions II: The Sequel
 Sec. 50-PU Jacuzzi Bubbles
 Sec. 51 This Section Has Been Redacted Per The Office Of Unidentified Space Things
 Sec. 52 Tropical Shirt-Wearing Hippo Photo Filter
 Sec. 53 Tacos!
 Sec. 54 Wool Beanies In Summer

B.L. 1982—3

PART III—GRATIS MUSIC

*(the term “gratis” means...do we really have to do this again?
It means BUD LIGHT RULES!)*

Subtitle A—Turn It Up To 11

Sec. 55	Concert Tickets On Us!
	Subtitle B—More “More More Awesomeness”
Sec. 56	The Stimmy Shimmy
Sec. 57	Bud Light Cans Cans
Sec. 58	Heretofore vs. Henceforth
Sec. 59	Finger Foods
Sec. 60-93.5	That’s My Summer Jam
Sec. 61-90S	Timeless Bangers
Sec. 62	Committee On Acoustic Affairs
Sec. 63	Federally Approved Dog Songs
Sec. 65-J5	Random Brain Teaser
Sec. 66	Eulogy/Elegy For Your Summer Tan
Sec. 67-BBQ	The Grillmaster
Sec. 68	The Bud Light Burger Cooking Guide
Sec. 69	Flip Flop Season Prep
Sec. 70°	Bud Light Thermometers
Sec. 71-H2OMG	Belly Flops
Sec. 72	Dog Plus-Ones
Sec. 73-BLT	Heros, Hoagies, Subs & Sammies
Sec. 74	Watermelon Ergonomics
Sec. 75W	Bud Light Lights
Sec. 75.6.20	Shark Peace Truce
Sec. 78	Free Coolers!
Sec. 79	Cooler Pools
Sec. 80S	Bee Stings & Former British Pop Stars
Sec. 81	Bud Light: The Movie
Sec. 82	Surf Satchels
Sec. 83	Double-Chuck
Sec. 84	Pool Noodles
Sec. 85	Fireflies
Sec. 86	Bears
Sec. 87	Recipe For Ben Franklin’s Potato Salad
Sec. 88	Beach Towel Spreading
Sec. 89	Mosquito Bite Ceasefire
Sec. 90-99	Great Moments In 90s Summer Party History
Sec. 1U1	Hammock Safety
Sec. 102	A Bunch Of Pie Charts
Sec. 103	Where Your Keys Might Be After A Day At The Beach
Sec. 104	Drinkable Area (Can)
Sec. 105	Drinkable Area (Bottle)
Sec. 106	Most Popular Summer Slogans
Sec. 107	Pie Pie Chart
Sec. 108	Best ‘Sun’s Out, [Blank’s] Out’ Phrases
Sec. 109	Best Place To Nap During The Summer
Sec. 110	The Perfect Summer Day

B.L. 1982—4



**PART I—GRATIS
SPORTS TICKETS**

B.L. 1982—6

Subtitle A— Tons of Tix

SEC. 1—FREE SPORTS TICKETS!

Pursuant to making Summer 2021 truly epic, Bud Light will give away up to 100,000 sports tickets (henceforth referred to as a ‘shipload’) to fans who can’t wait to see their favorite sports teams again because NOTHING goes better than Bud Light and sports. Tickets will be distributed across MLB and the NFL, NBA, WNBA, NWSL, and NHL. Bud Light acknowledges that fans of certain franchises may be more excited than others. But Bud Light assures you that THIS IS THE YEAR.

(1) BUD LIGHT LAWYER: It is not.

(2) The sports-adoring public have been seeing cardboard fans in stands for far too long, and deserves to yet again hear the mighty call of the beer vendor: ICE COOOOLD BUUUUDDDD LIIIIIGHT HER-REE!

(3) NOTA BENE (not sure what that means, but pretty sure it’s Italian): Any hockey fans who are upset that their league is last in the above list need to cool their skates, as the list is in alphabetical order.

(4) BUD LIGHT LAWYER: Um, is it?

B.L. 1982—7

Subtitle B— More Awesomeness

SEC. 2—GRONK

Bud Light to formally nominate Robert James Gronkowski (henceforth known as ‘GRONK’) to the newly created post of Secretary of Summer.

SUBSECTION A—Addendum to make May 14—Gronk’s birthday—National Gronk Day.

SUBSECTION B—Proposal to replace Teddy Roosevelt’s face on Mount Rushmore with Gronk’s.

SUBSECTION C—Both initiatives to become null and void if and when Gronk returns to his home planet.



FIGURE A

B.L. 1982—8

SEC. 3—OLD-TIMEY BICYCLE AND BATHING COSTUME HOME RUN

If a player in a beer league or softball league hits a home run while sitting on an old-timey bicycle and wearing an old-timey bathing costume, then... well damn, that's just impressive.

SEC. 3.14—NO MATH THIS SUM- MER!

If the first, second, or third segment rate for any 30-year period is less than 7.25 percent, such average shall be deemed -- WHO CARES!?! New proposal: NO MATH this summer! In your face, trigonometry!

SEC. 4—MT. RUSHMORE: THE WATER PARK

Bud Light proposes that Mount Rushmore be converted into a massive water park, thereby allowing Americans to gracefully slide down Teddy Roosevelt's moustache and do a cannonball off George Washington's nose.

ADDENDUM 1—Per Sec. 2, Subsection B, Teddy Roosevelt and his awesome moustache may in fact be replaced by Gronk and his awesome visage.

ADDENDUM 2—Is it moustache or moustache? Not to mention, ketchup or catsup? Bud Light demands answers! That's why we propose forming THE COMMITTEE ON

B.L. 1982—9

MOUSTACHES AND KETCHUP. Or should we title it the COMMITTEE ON MUSTACHES AND CATSUP?

ADDENDUM 3—Bud Light proposes forming a committee to decide what to title the aforementioned committee (“THE COMMITTEE ON NAMING THE COMMITTEE ON MOUSTACHES/MUSTACHES AND KETCHUP/CATSUP”), and while we’re at it, we also propose forming a committee to help prevent moustachioed persons from getting ketchup on their moustaches and a second committee to prevent mustachioed persons from getting catsup on their mustaches...unless said persons like having ketchup/catsup there, perhaps purposely saving it for later in the day? Kinda like how Abraham Lincoln was known for storing trail mix in his beard. (As seen in the director’s cut of his biopic from a few years back.)



FIGURE B

B.L. 1982—10

SEC. 5-87TE—THE SECRETARY OF SUMMER

Gronk here. Gronk writing legislative bill. Wow. Who saw that coming? Certainly not Mr. Zambrano (henceforth referred to as “Mr. Z”), one of my fave teachers. We did it, Mr. Z! The legislative process is a remarkable thing—one of the cornerstones of our democracy. Established in 1787 at the Constitutional Convention, the Legislative Branch is responsible for creating our country’s laws, from writing and proposing bills, to introducing them to the floor, to getting them ratified. Am I looking at Wikipedia as I write this? Yes, but I’m looking at an article on SHARKS, which I can’t get enough of.

Did you know sharks date back over 400 million years? Talk about Boomers. Zinger!!! There are also a handful of sharks who have been known to show up in fresh water.

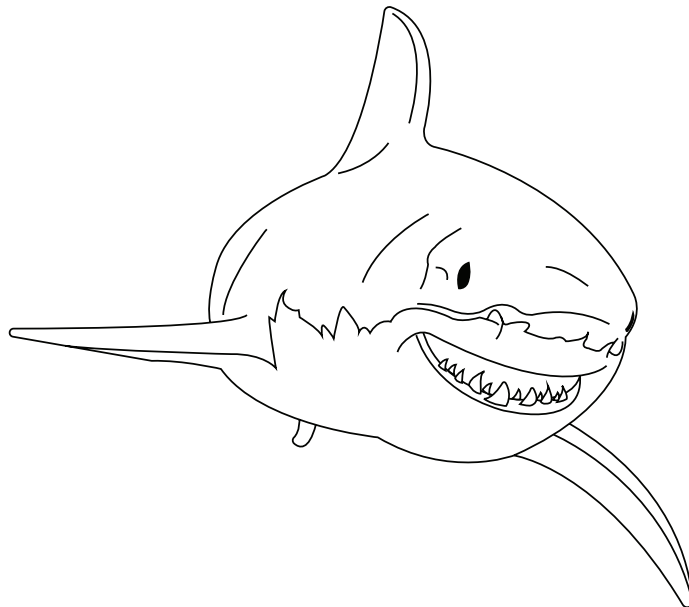

FIGURE C

B.L. 1982—11

Can you imagine that? You're just floating down one of those lazy rivers, maybe in one of those double tubes, and a BULL SHARK rises out of the water!!!

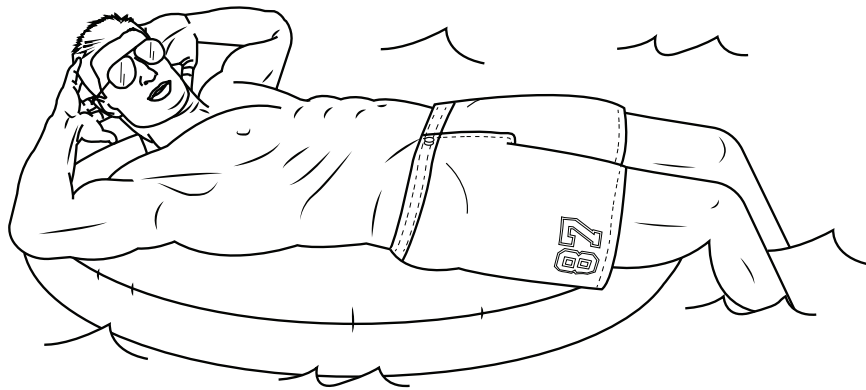

FIGURE D

Holy cow, that would be scary. Yep, even Gronk gets scared sometimes. Anyway... sharks. Nature's badasses. Okay, back to why I'm here. To talk about sharks. And also to accept your nomination as 'Secretary of Summer.' Thank you, Bud Light and the good people across America! I won't let you down. In fact, I'm ready to get started right now. As 'Secretary of Summer,' I propose the following:

SUBSECTION 1—All sub sections shall henceforth be served in three-foot-long sections. This also applies to hoagies, torpedoes, heros, and grinders.

SUBSECTION 2—More a reminder than a legislative proposal: Running through a water-spraying fire hydrant in the street is, and

B.L. 1982—12

will continue to be, a blast.

SUB-SUBSECTION 2.1—Running through a sprinkler on someone else's property will also continue to be a blast.

SUBSECTION 3—Can we please please please change the name of the position I play? TIGHT END. I mean, who came up with that? It is, hands down, the most ridiculous sounding position in any sport. What's that? COXSWAIN, you say? I have no idea what that is, but yeah, that word is also pretty damn funny. But TIGHT END. C'mon. I mean, we might as well just call it FIRM RUMP. Or COMPACT DERRIERE. Or even UNYIELDING BUTTOCKS. I propose we change it unilaterally to: OFFENSIVE GRONKMAN.

SUBSECTION 4—Anyone who attends a wedding this summer and shows up to the wedding wearing a suit with the sleeves torn off shall receive a Bud Light, compliments of the bride's parents. Thank you, Walt and Linda.

SUBSECTION 5—Any person or persons caught destroying a sandcastle will have to answer to me.

SUBSECTION 6—Any person who builds a GRONK SAND STATUE will win my eternal gratitude.

SUBSECTION 7—Feel free to jump in your neighbors' pools this summer. If they give you any grief, just tell 'em Gronk sent you.

SUBSECTION 8—All persons must ride in convertibles this summer. If your vehicle is not a convertible, simply tear off the roof with your bare hands.

B.L. 1982—13

SUBSECTION 9—I propose that at least once every day you randomly stop what you're doing and start dancing like you just crossed the goal line. I mean REAL-LY GET DOWN. Because let's be real: Every day this summer is gonna feel like you just scored a touchdown, right? And if you have the luxury of dancing like that without having to stiff-arm anyone or dive head first into an end zone pylon, well, all the better! **#BudLightDoTheGronk.**

SOME STARTER END ZONE DANCES FOR YOU:

- The Chest Bump (bump chest with another person)
- The Butt Bump (bump, um, butts with another person)
- The Gronk Honk (mime honking a truck horn)
- The Muscle Kiss (kiss enormous bicep)
- The Muscle Makeout (a hotter version of the prior one)
- The Hut, Hut, Spike! (mimic receiving snap and spiking it)
- The Big Gronkowski (mime bowling, preferably in a bathrobe, sunglasses, and long-haired wig)
- The Gronky Shuffle (freeform dancing)
- The Selfie Stop (during the dance suddenly stop and pretend to take a selfie of yourself)
- The Wet Dog Shake (shake like a wet dog coming out of the pool)
- The Fish Out Of Water (flop around on ground like a fish out of water)
- The Cannon-bowling-ball (jump like a

B.L. 1982—14

cannonball, land on the ground, then roll into your friends like a bowling ball)

- The Drone (start as a ball on the ground and then spin and hold your bent arms at the elbow near your head and keep spinning and swooping around until you hit something or run out of batteries 8 minutes later)

- The Trying On Cowboy Boots (act like it's really hard to take your boots off and then very hard to put new boots on)

- The Beginning Surfer (start on the ground, struggle to stand up on two legs, then wipe out like the board shot out from under you)

SEC. 6—HYBRID SPORTS

Per the recent introduction of Footgolf (henceforth known as and heretofore referred to as, um, “FOOTGOLF”) to the American sports landscape, this summer Bud Light will apply for funding to introduce the following HYBRID SPORTS:

- (A) Basketball + Rugby = Basketbugby
- (B) Surfing + Equestrian = Horse-Surfing
- (C) Football + Sailing = Failing
- (D) Swimming + Lacrosse + Field Hockey = Swimming Across A Field
- (E) Softball + Soccer = A “Soft Socks” Competition
- (F) Synchronized Swimming + Rock Climbing = Synchronized Rock Climbing
- (G) Field Hockey + Track & Field = Field & Field

B.L. 1982—15

SPORT 1	SPORT 2	SPORT 3 (if applicable)	NEW COMBINED SPORT
Basketball	Rugby		Basketbugby
Surfing	Equestrian		Horse-Surfing
Football	Sailing		Failing
Swimming	Lacrosse	Field Hockey	Swimming Across a Field
Softball	Soccer		A “Soft Socks” Competitioon
Synchronized Swimming	Rock Climbing		Synchronized Rock Climbing
Field Hockey	Track & Field		Field & Field

FIGURE E

SEC. 7.3—FOURTH OF JULY EVE

Bud Light hereby requests that the date of July 3 henceforth be acknowledged as ‘FOURTH OF JULY EVE.’ Said date shall also be considered a federal holiday because it’s well understood that one can’t have a truly great Fourth of July unless one knows they can properly ramp up on the Third, and, while we’re at it, let’s also throw in the Fifth. And if we need to give the Fifth of July a catchy holiday name per the CATCHY HOLIDAY NAME ACT OF 1776, we propose calling it ‘EXTRA FOURTH OF JULY.’

SUBSECTION 7.3B—If Section 7.3 is enacted, this subsection shall serve to detail possible Fourth of July Eve traditions, including the following:

- (1) Hanging in one’s fridge a stocking full of hot dogs, sausages, and bratwursts to grill

B.L. 1982—16

the next day.

(2) Gifts of frisbees, fireworks, and floaties are to be placed around the American Flag.

(3) A Bud Light and a slice of apple pie shall be left near the flag at night for the ghost of Benjamin Franklin to consume in the midst of his annual pilgrimage to PHILLY PHILLY to sign the Declaration of Independence.

(4) Let's talk more about this whole ghost of Benjamin Franklin story. Maybe he also travels on a carriage of eight flying turkeys, because he said that turkeys should be the national bird over eagles? Can you believe that? Or does he ride an electric flying kite? That seems pretty badass, let's go with that one.

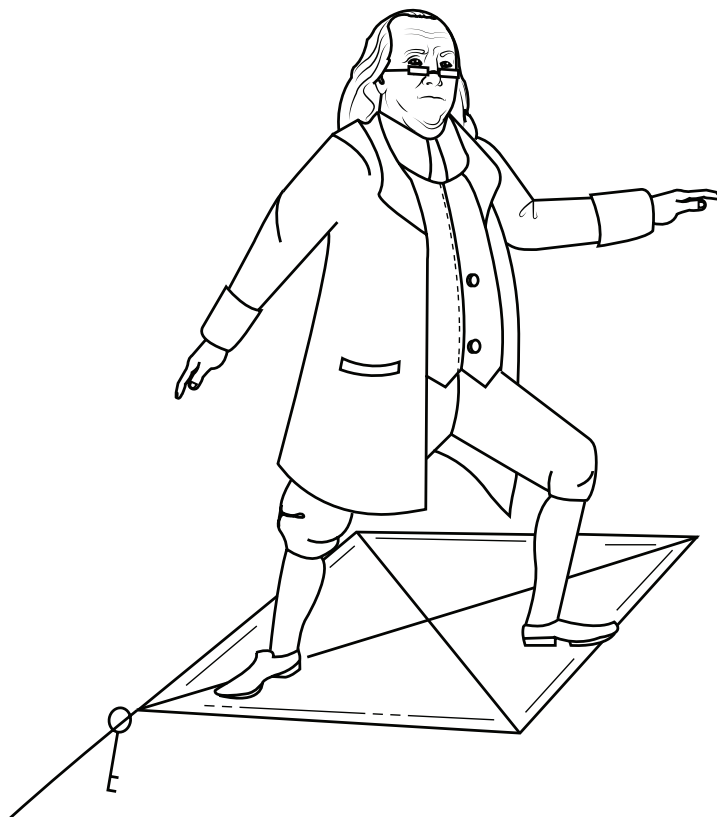

FIGURE F

B.L. 1982—17

SEC. 7 3/8—SLIGHTLY ASKEW HATS

To look as cool as possible while protecting yourself from the sun, Bud Light asks that all baseball caps, newsboy hats, floppy hats, fedoras, berets, beanies, bonnets, bowler hats, porkpie hats, dunce caps, party hats, cowboy hats, tam o'shanters, top hats, ushankas, and pointy wizard hats **BE WORN SLIGHTLY ASKEW** from May 1 through August 31. Persons with oblong faces are exempt. Does not apply to hardhats, pith helmets, or sailor caps if you're in fact a sailor sailing on a sailboat. Say that three times fast: Sailor sailing on a sailboat, sailor sailing on a sailboat, sailor sailing on a sailboat. Did you really just do that? Wow. Um, thanks? Also, if your face has sharp angles, we strongly advise you to choose hats with asymmetrical lines...and maybe see a doctor.

SEC. 8—CONGA LINES

Conga lines shall be deemed unlawful in Cattywampus County from Memorial Day through Labor Day.

SUBSECTION 8CL—Cattywampus residents caught limboing in public shall be given a warning and/or a Bud Light hat.

B.L. 1982—18

SEC. 9.5SZ—BOAT SHOES

Bud Light to apply for additional funding to study the rate at which guys wearing boat shoes turn out to be named TRISTAN, TRENT, THAD, COOPER (henceforth known as “Coop”), BLAKE, or BLAINE.



FIGURE G

SEC. 10—TINY BATHING SUITS

Males shall hereby be allowed to wear tiny swim briefs (you know the ones we’re talking about) if—and only if—the wearer can prove they are actively on their way to a swim meet or are in fact European.

B.L. 1982—19

SEC. 11—TINY AND NOT SO TINY UMBRELLAS

Bud Light calls on the nation's umbrella manufacturers to ramp up production of the following:

(A) Large beach umbrellas to sit under and enjoy a cold Bud Light

(B) Tiny umbrellas to put in a cold Bud Light and enjoy while sitting under a large beach umbrella

Bud Light further recommends increased R&D funding toward the following contraption: a tiny umbrella for drinks whose top extends out to form a straw, so that the umbrella never needs to be removed.

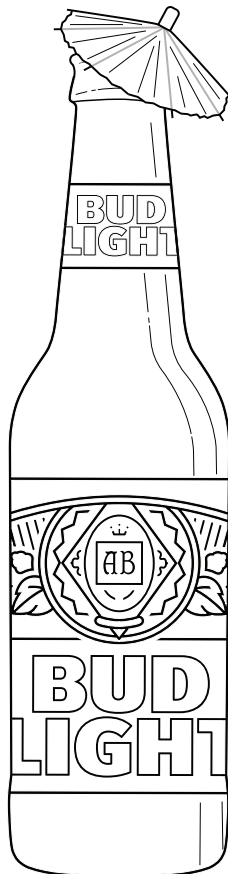

FIGURE H

B.L. 1982—20

SEC. 12—FAVORITE WAY TO COOL DOWN

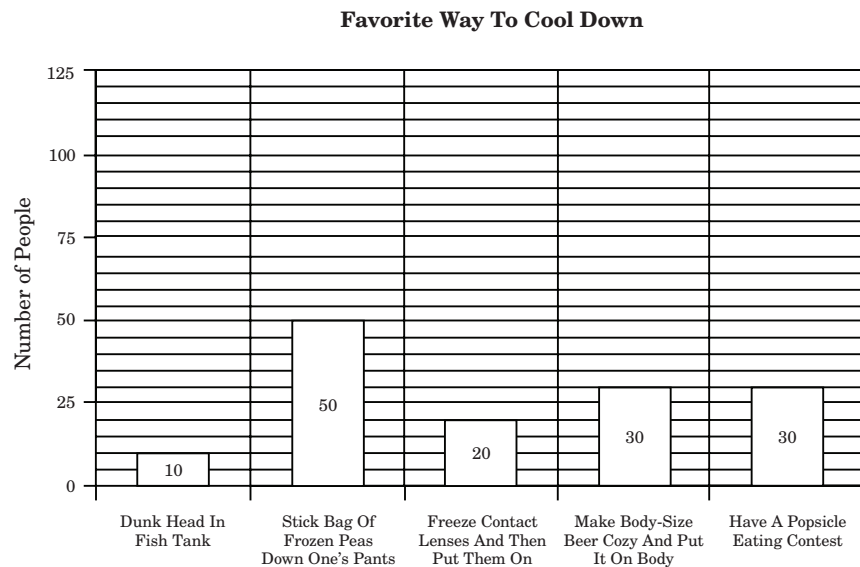

FIGURE I

SEC. 13-SH8DS—SUNGLASSES SUPPORT

Bud Light extends emotional support to any individual(s) OR person(s) OR people(s) who believe they have lost their sunglasses when, in fact, their sunglasses are on top of their heads. Whenever possible, a local authority will be dispatched to the site of the confusion and say, “Oh, they’re, uh, actually on your head.”



FIGURE J

SEC. 14—SUMMER TUESDAYS

Through Labor Day 2021, all forthcoming “Summer Fridays” shall henceforth begin at noon on Tuesday, and extend until the following Monday at noon.

SEC. 15—OUT-OF-OFFICE AUTO REPLIES

In lieu of commonly used but insincere out-of-office auto-reply emails, Bud Light proposes widespread use and acceptance of the following more HONEST out-of-office auto-reply emails for Summer 2021:

B.L. 1982—22

(I.) “Please note that I am currently in the office, I just don’t feel like answering emails today or any day for the rest of the summer.”

(II.) “I am out of office today and unable to reply because I threw my laptop out a window because I don’t want to answer emails anymore.”

(III.) “Hi! I will be out of office from today through the rest of the week. Truth be told, I might be out of office for good. I don’t think my boss likes me. That’s fine, though. He kinda sucks, IMO.”

(IV.) “I am out of office today. If this is an emergency, contact 9-1-1. But let’s be honest, Todd. We both know this isn’t an actual emergency.”

(V.) “I am traveling this week, and even though I totally have my usual access to email, I’m going to pretend that it’s impossible to check email when you’re traveling and just kind of hope that you buy it.”

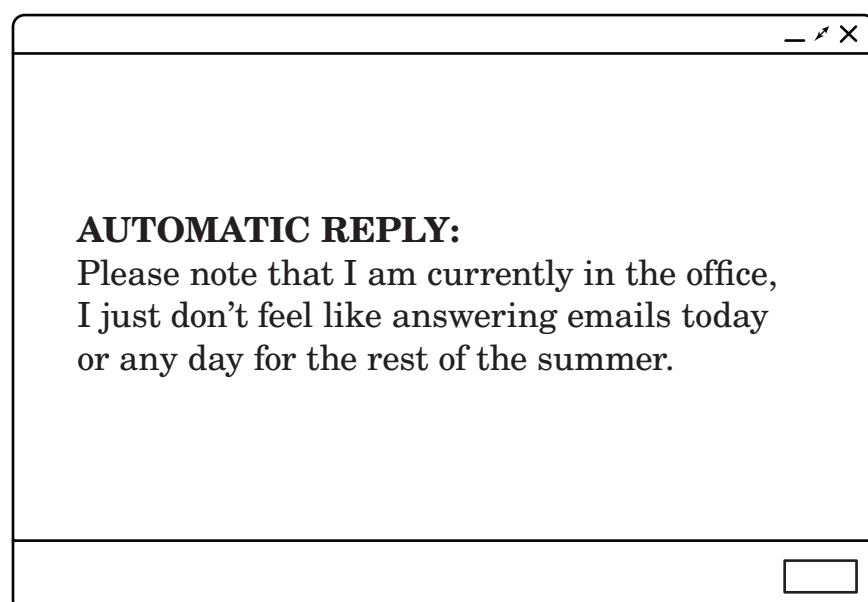

FIGURE K

B.L. 1982—23

SEC. 16—A NOTE FROM THE HOUSE SITTER

Welcome back! I hope the coast was a total blast. So... just to catch you guys up, a few things I should prolly mention.

- You guys are completely out of food. I kindly cleared the fridge out so things wouldn't go bad, but I also ate everything in the pantry, the garage freezer, and the entirety of the emergency stockpile in the cellar (and trust me it was an emergency).

- I also drank your Bud Light, but I replaced it. But then I drank that too. So I guess you're out of Bud Light now.

- I don't know how it happened, but a dozen RACCOONS are squatting in your garage and have completely taken over. If you want anything out of there you gotta pay them in loose paper bags of fast food.

- All the mail is on the kitchen counter. Some of it was already opened when I got to it, so I took the liberty of making a list of all the bills you're delinquent on. It's way longer than I would've guessed!

- Pretty sure those billiard balls were already stuck in the ceiling when I got here, so I don't know what's going on there.

- Don't open the hall closet. Like, ever again.

- I lost some ham in the big sofa. I know I brought ham over to the sofa, I know I fell asleep with ham in my hand, but when I woke up...no idea.

- The raccoons also found the box of bub-

B.L. 1982—24

ble bath powder in the garage. They thought it was sugar or something and tried to eat it. When I saw them foaming at the mouth, I was like “Oh no... where’s my phone b/c this would kill on TikTok!”

- I mention the bubble bath powder because they broke into your hot tub (I mayyyy have left the top off, my b.) and, long story short, they’ve been taking non-stop bubble baths out there.

- BUT, on the bright side, I started a social account called @bubblebathraccoons and it blew up. We gettin’ all sorts of branded deals now, it’s nuts. We’re on the road right now taking bubble baths in hot tub stores.

- They also broke into the rest of the house and trashed the place. Sux.

Have a good one!

Craig

**SEC. 17—WORLD TURTLE DAY,
NATIONAL FRIED CLAM DAY,
GORGEOUS GRANDMA DAY
(OR... “SUMMER HOLIDAYS”)**

Memorial Day. Fourth of July. Labor Day. Why should they have all the fun? Bud Light recognizes that there are PLENTY of other holidays during the summer to celebrate with Bud Light, including, but not limited to, the following:

May 3 National Lumpy Rug Day

May 5 National Hoagie Day

May 7 National Roast Leg of Lamb Day

May 8 National Mini Golf Day

B.L. 1982—25

May 9 National Lost Sock Memorial Day
May 12 National Limerick Day
May 13 National Crouton Day
May 14 NATIONAL GRONK DAY
May 16 National Sea Monkey Day
May 18 National Cheese Soufflé Day
May 20 National Quiche Lorraine Day
May 23 World Turtle Day
May 24 National Escargot Day
May 29 National Paperclip Day
June 1 National Heimlich Maneuver Day
June 2 National Rotisserie Chicken Day
June 4 National Donut Day
June 7 National VCR Day
June 13 International Axe Throwing Day
June 14 International Bath Day
June 18 National Flip Flop Day
June 21 Go Skateboarding Day
June 22 National Onion Rings Day
June 25 Take Your Dog to Work Day
June 28 National Paul Bunyan Day



FIGURE L

B.L. 1982—26

June 30 National Meteor Watch Day
 July 3 National Fried Clam Day
 July 7 National Dive Bar Day
 July 11 Joe Lennon's Birthday (Sr. Director, Bud Light at Anheuser-Busch; he insisted that we include this)



FIGURE M — MR. LENNON

July 13 National Beans 'N' Franks Day
 July 16 National Corn Fritters Day
 July 23 Gorgeous Grandma Day
 July 27 National New Jersey Day
 July 28 National Waterpark Day
 July 29 National Chicken Wing Day
 August 2 National Coloring Book Day
 August 6 INTERNATIONAL BEER DAY!!!
 August 8 International Cat Day
 August 9 National Veep Day
 August 10 National S'mores Day
 August 13 Left-Handers Day
 August 15 National Leathercraft Day

B.L. 1982—27

August 16 National Roller Coaster Day

August 17 Black Cat Appreciation Day

August 18 National Fajita Day

August 21 National Spumoni Day

August 24 National Waffle Day

August 26 National Dog Day

August 30 National Toasted Marshmallow Day

September 3 U.S. Bowling League Day

September 4 World Beard Day AND National Tailgating Day (For the love of all things good, don't make me choose!)

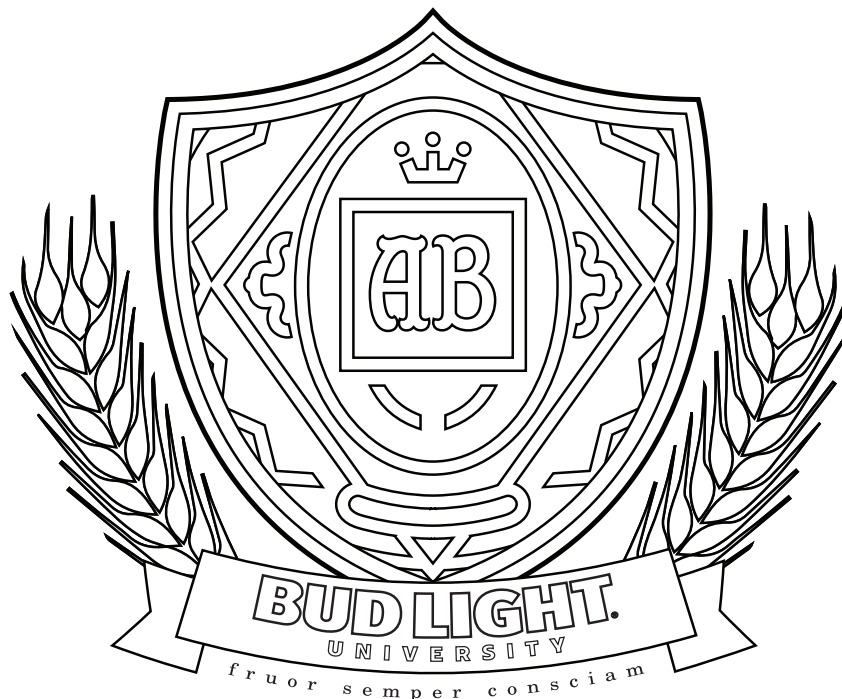

FIGURE N

B.L. 1982—28

SEC. 20—BUD LIGHT UNIVERSITY

We propose the establishment of BUD LIGHT UNIVERSITY (henceforth referred to as 'BLU') in order to educate all people of America on the fundamentals of summer fun. Our INTRO TO SUMMER course will follow the below syllabus:

DESCRIPTION—This introductory seminar will cover the basic principles of summer fun, ensuring that all 21+ students can practice summer fun safely and immediately.

REQUIRED READING

- Treatise on Hot Dogs
- The Philosophy of Deodorant
- Gaming: Volumes 1–50
- The Physics of Hacky Sack
- The Economics of Flip Flops
- Principles of Mac & Cheese
- Introduction to Sandcastles

MONTH 1—In the first month, we will introduce basic concepts such as keeping one's Bud Lights and Bud Light Seltzers cool; how to wear linen without getting it all wrinkly; and how to maintain your T-Zone in 100-degree weather. There will be a 20-minute physical education portion in which students will be required to attempt to put sunscreen on their own back.

MONTH 2—BLU students will conduct field studies to determine who would be a great person to have a cold beer with. They will expand their problem-solving skills by trying to find their friends in the quad at dusk with-

B.L. 1982—29

out the benefit of both parties shouting into their phones “Do you see me? I’m over here. No, here”; cramming a day’s worth of snacks and drinks into one cooler without the sandwiches getting crushed; and preventing their hair from getting frizzy in humid weather.

MIDTERM—BLU students will be required to recite the lyrics of three classic summer songs from the 80s and 90s while balancing a boombox on their shoulder with no hands.

MONTH 3—BLU students will develop critical analytical skills such as how to get sand out of their swim trunks and determining the exact number of shirt buttons to leave unbuttoned. In-class assignments will include trying to eat an ice cream cone on a hot day without even a teeny drop of the ice cream dripping onto your fingers or having to resort to licking around the cone in a circular motion to prevent such dripping and making everyone a little disgusted with the fact that they had to watch you eat ice cream like that.

FINAL EXAM—BLU students will be required to do an in-class presentation of grilling a medium-rare burger to perfection. Students may not use notes or a thermometer, but may call their dad or another father figure if needed. Students must also demonstrate the ability to carry a cooler, beach umbrella, beach chair, and fake shark fin without sweating profusely.

B.L. 1982—30



FIGURE O

SECCIÓN 21—ON PIRAGUAS

In an effort to support the return of piragua pushcarts everywhere, Bud Light will buy an extra round for the piragüero(a) near you if said piragüero(a) sets up shop within 100 feet of his or her local bar.

ADDENDUM—Bud Light will also repurpose unused piragua ice blocks to further their mission to ensure Bud Lights remain cold az'hell and chill more beer. (see SEC. 78—FREE COOLERS!)

SEC. 22-HNG10—SURFBOARD CONSTRUCTION

American corporations are encouraged by Bud Light to immediately enact a PAID

B.L. 1982—31

SURFBOARD CONSTRUCTION LEAVE policy, whereby they encourage employees to take three weeks to go out, find the raw materials, build their own surfboard, and then catch the perfect wave.

SEC. 23—RAINBOWS & ROM-COMS

In order to maximize time in the sun, Bud Light calls for the regulation of cloud appearances throughout the summer. Cumulus, cirrus, and other cloud formations will only be permitted to appear when shade is desired, or if the cloud's presence makes the sky look particularly gorgeous. Furthermore, only the following types of rain will be accepted during Summer 2021:

(A) Rain where it's still sunny out so that a beautiful rainbow forms.

(B) Downpours are allowed only at moments corresponding with the

(I.) end of romantic-comedy-situations-happening-in-real-life or

(II.) at the beginning of romantic-comedy-situations-happening-in-real-life (see Romantic Comedy Act of 1999, Section 4U: "Official Classifications As To What Does And Does Not Qualify As A 'Meet-Cute' Encounter")

SEC. 24J-SKI—JET SKI FACE

All people across this GREAT NATION should set up time prior to 'Jet Ski Season' with their nearest jet ski-riding friend(s) for

B.L. 1982—32

a training session on how to project that look of self-satisfied confidence they've mastered while riding said recreational water vehicle.

ADDENDUM—Session does NOT need to take place on the water. Session can take place while sitting on a jet ski still on its trailer and parked in a driveway.

SEC. 25—SHORT PANTS

For the duration of Summer 2021, all bathing suit trunks longer than the knees will be referred to as 'short pants' or 'bathing costumes.' That's all.

B.L. 1982—33



PART II—GRATIS BEER

B.L. 1982—35

Subtitle A— The First One Is on Us

SEC. 26—HEAR! HEAR! BEER! BEER!

One Bud Light for people of legal drinking age! In accordance with the newly declared FIRST ONE IS ON US ACT OF 2021. The fun-loving people of our GREAT NATION are ready to get back together SAFELY and, pending approval by the Bud Light Secretary of Summer (see SEC. 5-87TE), the BEER WILL BE ON US. Beers to be distributed to the following eligible applicants:

(1) Individuals between the ages of 21 and 30, who, per the MILLENNIAL ACT OF 2019, have termed everyone over the age of 30 as ‘boomers.’

(2) Individuals 30 and older, who, per the recently ratified BOOMER ACT OF 2021, want to remind everyone under the age of 30 to show a little more respect to those who have come before them.

(3) They’d also like to remind millennials that millennials has two N’s in it.

(4) BUD LIGHT LAWYER: Me again. You guys up for a little legalese?

(5) YOU: Boo!!! Boo!!!

(6) US: Yeah! Boo, Bud Light Lawyer! Have you no shame? What do you say to that, Bud Light Lawyer?

(7) BUD LIGHT LAWYER: Objection! Overruled! Sustained! Pure speculation! Look—a squirrel!

(8) Touche, Bud Light Lawyer. Touche.

B.L. 1982—36



BUD LIGHT LAWYER

B.L. 1982—37

Subtitle B— More “More Awesomeness”

SEC. 27—JULY 79TH

In an effort to extend the Summer Season, Bud Light proposes to expand the months of June, July, and August to thrice their current duration. Each month shall now last 90 days. Proposal to be reviewed by committee on June 42nd, July 79th, and August 88th.

SUBSECTION TO SEC. 27—To ensure that a year still consists of 365 days, the months of January, February, and March are permanently canceled. In your frostbitten face, February! Henceforth, all calendars shall appear as such:

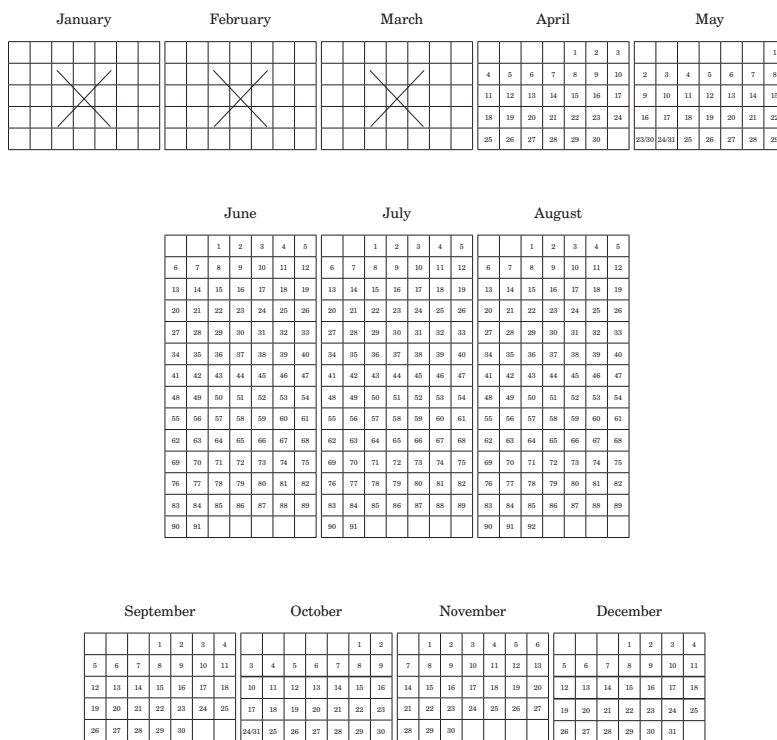

B.L. 1982—38

SEC. 28—STATUE OF LIBERTY SUMMER APPROPRIATE CLOTH- ING

In light of the humidity and extreme heat conditions projected for Summer 2021, Bud Light proposes that the Statue of Liberty henceforth be allowed to wear seasonal shorts or a dress with breathable fabric so as to avoid the inevitable “pooling of sweat behind one’s knees.”

ADDENDUM 1—In addition, the crown shall be replaced with a wide brim hat in order to provide maximum sun protection for Lady Liberty, and the torch shall be replaced by a mini cooling fan.

ADDENDUM 2—Request for additional funding to appropriately outfit other historical figures/sites this summer, beginning with the Lincoln Memorial. Bud Light proposes paying respect to our nation’s 16th president by allowing him to wear something a bit more casual this summer. May we suggest replacing that suit jacket and shirt with a slim-cut tank top? And those trousers with capris? Yes, that will work nicely. The final touch: Let’s trim down that beard to just a ’stache.

SEC. 29—MANDALS

Bud Light is lobbying for stricter enforcement of THE MANDALS MANDATE OF 1978, which bans mandals on all U.S. male persons, except those returning from European vacations (who are given a two-week leniency period to ease out of said mandals

B.L. 1982—39

due to feeling like the mandals were actually kinda working for them while they were overseas, and that Yeah, maybe I can actually rock these sweet open-toed leather bad boys when I return home to the good ole U.S.A).

ADDENDUM 1: You were wrong.

ADDENDUM 2: Exceptions will continue to be made for the following individuals and mandal enthusiasts:

ANDREW “MAXIMUS” GOELER, Vice President, Bud Light Marketing at Anheuser-Busch

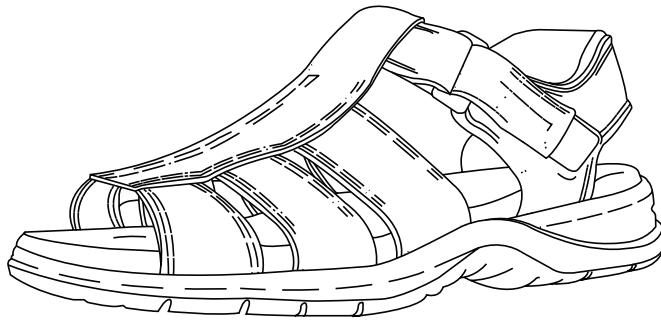

FIGURE Q

SEC. 30-SPF—SUN PROTECTION

SPF (hitherto the truncated form of ‘Sun Protection Factor’) shall hereby be expanded to also mean the following phrases:

- Sick Party, Fred!
- Sausage Pizza with Fennel (surprisingly good!)
- Seniors Playing Frisbee
- Swimming Pool Fun
- Sweet Pad, Frank

B.L. 1982—40

- Strawberry Popsicles? F-yeah!
- Sandals Put on Feet

**Did you know that SPF is an initialism, and not an acronym? If you did, well then you're a LIAR! And a WORD NERD! And OUR EDUCATION SYSTEM'S GREATEST ACHIEVEMENT. Hail to you, Master Grammarian. Or is it Grandma-rian? Probably the former.*

SEC. 31-K9—DOGS IN SUNGLASSES

Bud Light, in accordance with the First Dogs (henceforth referred to as “Mary Pup-pins” and “Snuggly McRuffers”), has deemed the entire month of August DOGS IN SUNGLASSES MONTH. From August 1 through August 31, all dogs are encouraged to wear sunglasses, regardless of weather or whether they are indoors or outdoors.

SUBSECTION A—The Office of the President’s Dogs (the “Office” is in actuality an oval doghouse) further recommends the following breeds wear sunglasses due to optimal snout length, which makes their noses ideal placeholders for sunglasses, as well as for sniffing (due to the 200+ million scent receptors in said schnozzes):

- Borzoi
- Salukis
- Dachshunds
- Afghan Hounds
- Bloodhounds
- Greyhounds

B.L. 1982—41

- Ibizan Hounds
 - Pharaoh Hounds
 - Whippets
 - Rough Collies (known for their ability to bark on command: “Ruff, Collies!”)
 - Bull Terriers
-

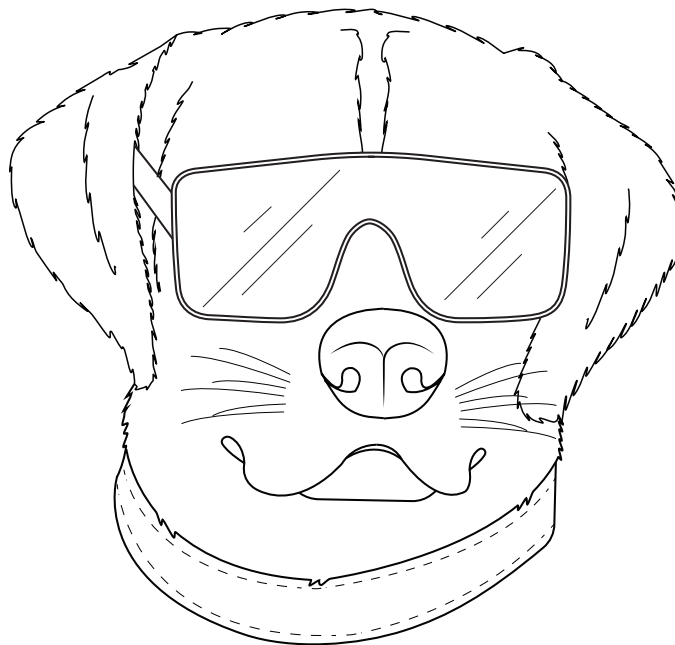

FIGURE R

SEC. 33-WEEEE—WATERSLIDE EXCLAMATIONS

Bud Light affirms that the following exclamations are perfectly acceptable for any person or persons sliding down a waterslide:

- (1) (A) “Weeeee!”
(B) “Weeeeeee!!”
(C) “WEEEEEEEEEEEEEEEEEE!!!!”
- (2) (A) “Aaah!”
(B) “Aaahhhhhhhh!!!”
(C) “AAAHHHHHHHHHH!!!!!!!”
- (3) “This is a quite pleasurable diversion.”

B.L. 1982—42

SEC. 34-36W—JORTS

Bud Light will provide wardrobe assistance for any male person in a bar wearing denim cut-off shorts (henceforth referred to as “jorts”), particularly if they’re short shorts jorts.

RIDER TO SEC. 34-36W—Bud Light will also provide fashion funding to assist males wearing shark-tooth necklaces, blazers with shorts, blazers with no shirt underneath (henceforth referred to as “bare-chested suits”), finger shoes, deep V-neck T-shirts, and any outfit that exposes male midriff.

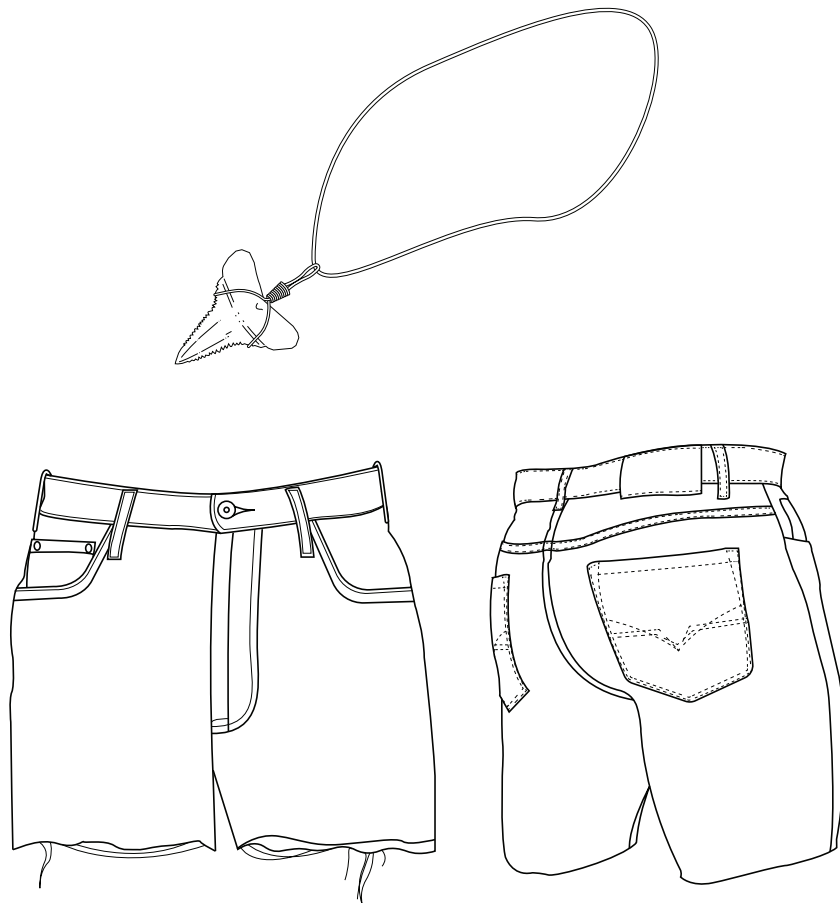

FIGURE S

B.L. 1982—43

SEC. 37-TNT—SUGGESTED THINGS TO BLOW UP IN SUM- MER BLOCKBUSTERS

In order to keep Summer 2021 banging and popping, Bud Light respectfully asks Hollywood to consider blowing up the following items in upcoming summer blockbusters:

- (I.) a mime
- (II.) a meme
- (III.) a mime meme
- (IV.) the world's largest watermelon
- (V.) a giant bowl of pudding
- (VI.) a giant radioactive hamster
- (VII.) space werewolves
- (IIX.)* a tofurkey
- (IX.) one of those automatic coin-sorting machines
- (X.) space vampires
- (XI.) a banana split
- (XII.) a tandem bicycle
- (XIII.) a mandroid named Mandy who only communicates through showtunes
- (XIV.) a pair of mandals
- (XV.) space mummies
- (XVI.) a halibut
- (XVII.) space mimes
- (XVIII.) a lazy Susan
- (XIX.) an active Susan
- (XX.) space Frankensteins
- (XXI.) a clown car (after it empties, of course; no matter how long it takes said clowns to disembark)
- (XXII.) a short stack of pancakes
- (XXIII.) a tall stack of pancakes

B.L. 1982—44

(XXIV.) a giant donut on top of a donut shop that also serves as a secret lair for Dr. Donut, an evil scientist who is widely credited with/vilified for being the first person to put bacon on a donut

(XXV.) A GIANT CAN OF BUD LIGHT

**“Roman numerals? Yecch. What a waste of time. When are we EVER going to need to know how to use Roman numerals?”*

SEC. 38—MIME MEMES

We have no legislative proposals for MIME MEMES (short of our request for Hollywood to consider ‘blowing them up,’ per SEC. 37-TNT). We just thought it was a fun phrase to say. MIME MEMES. Go ahead, say it with us: MIME MEMES. Feels good, right?

ADDENDUM B—(also known as ADDENDUMB because, um, it’s dumb)—When we say consider ‘blowing them up,’ you better believe we mean it in both senses of the word. To be clear: Bud Light wants to see MIME MEMES blow up on social. And this request, nay, duty falls not to the auteurs making films, but to the amateurs making memes. You know who you are. Use your special powers to make MIME MEMES blow up on social this summer with **#BudLightMimeMemes**. The world will thank you. Okay, maybe not the world. But Bud Light will thank you and that will mean...the world to you? (Realize we’re kinda stretching it here. Gotta go now. **#BudLightMimeMemes!!!**)

SEC. 39—MAN CHILD(S)

Bud Light proposes the MAN CHILD ACT OF 2021: All families with male dependents aged 30 and older who still reside in the family basement (said dependents are hereafter referred to as the “MAN CHILD”; should a family have—for the love of all things great and small!—more than one of these man childs, they shall collectively be termed “MAN CHILDREN” and the parents shall be immediately fast-tracked for canonization) shall feel fully entitled to suggest that said MAN CHILD or MAN CHILDREN should at least do some basic household chores, regardless of whether the MAN CHILD or MAN CHILDREN just needs a few more hours to put the finishing touches on his/their podcast or get to the next level in that game with all the elves and warlocks.

SEC. 40—BEST & WORST THINGS TO DO IF YOU GET STUNG BY A BEE

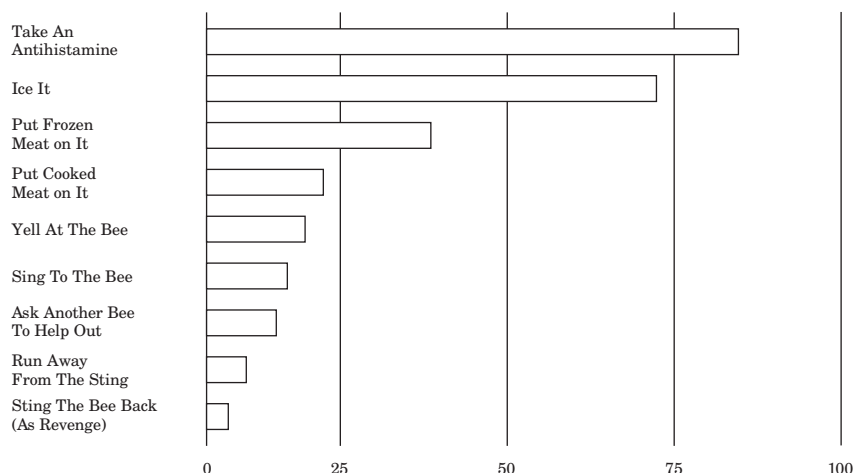

FIGURE T

B.L. 1982—46

SEC. 41—APPROVED FATHER’S DAY TOPICS

Bud Light recognizes that America’s dads would love nothing more than a bit of peace and quiet this Father’s Day. But we also recognize—and Dad does too, though begrudgingly—that it’d be rude to ignore any offspring that might come to visit. That’s why we worked with the NATIONAL CONVERSATION COMMISSION (“NCC”) to put together a list of topics that will allow dads to engage in conversations more easily on JUNE 20, while watching their favorite baseball team or their favorite British crime procedural on TV and enjoying a cold Bud Light...while trying to figure out how to get their recliner to that angle they really like.

FEDERALLY APPROVED FATHER’S DAY TOPICS:

- General MacArthur
- The 84th Infantry Division
- U-Boats
- Any sort of boats
- Anything related to WW2
- His favorite screwdriver
- How they changed the magazines in the doctor’s waiting room and how he doesn’t like that
 - Can you look at this rash?
 - How to properly clean your outdoor grill
 - Have you cleaned your grill? You really need to do so every summer.
 - That g*ddamn team from Queens
 - That g*ddamn squirrel in the backyard, you know the one

B.L. 1982—47

- His new flossing method
- The smoke alarm acting up again
- The neighbors bought a new car. Their second one in the past two years.
 - A new food that's been giving him heartburn
 - The neighbors won't rake their leaves and now the leaves are blowing into his yard
 - That dang squirrel is back
 - Ernest Shackleton
 - Boats again
 - Icebergs
 - The goldfinch he spotted on his walk
 - Speaking of goldfinches, the neighbors (the Goldbergs) bought a new car
 - The best binoculars for birding
 - The Goldbergs are extending their driveway
 - How would you like your burger?
 - His plans for going to war against that squirrel

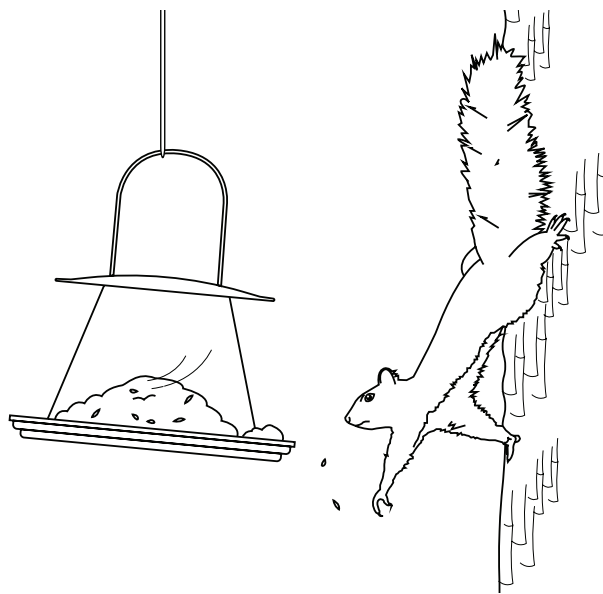

FIGURE U

B.L. 1982—48

**SEC. 42-STL—RESIDENTS
NAMED LOUIS OR LOUISE**

During the month of July, Bud Light will give everyone in St. Louis named Louis OR Louise a free T-shirt that says: “My parents named me Louis/Louise and all I got from Bud Light was this awesome T-shirt.” Residents named Louis or Louise who have also been canonized as saints might also be eligible to receive a pair of Bud Light socks (while supplies last).



FIGURE V

B.L. 1982—49

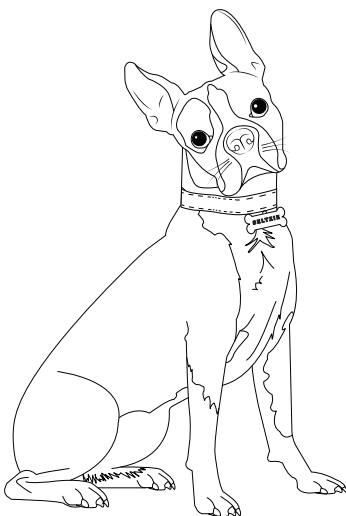

FIGURE W

SEC. 43—PUPPIES!

If you get a puppy this summer and name it Seltzie, Bud Light will give Seltzie a month’s worth of biscuits.

SEC. 44—COLOGNE SUMMER AIR ADVISORY

Please use the following AIR QUALITY GUIDE when consuming Bud Light this summer:

Average Summer Air Quality Index As Measured In Micrograms Per Cubic Meter of Cologne

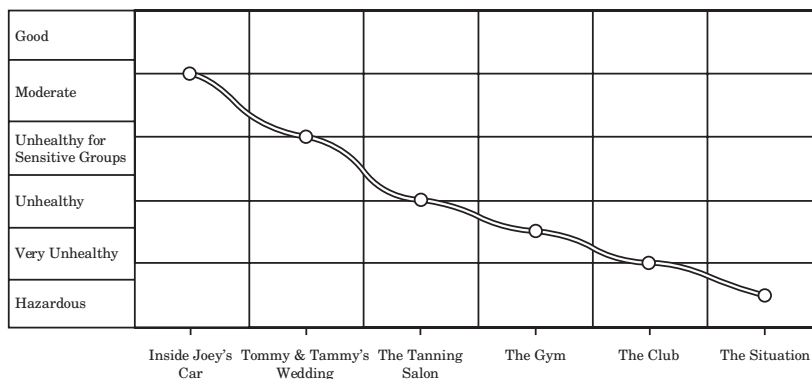

FIGURE X

B.L. 1982—50

SEC. 45—SUMMER BLOCKBUSTER SUGGESTIONS

Bud Light approves enjoyment of Bud Light and Bud Light Seltzer while watching or rewatching any/all summer blockbuster movies.

SUBSECTION (II): Bud Light additionally approves the enjoyment of Bud Light beverages while watching any/all of the following as-yet-unmade summer blockbuster movie sequels:

- *Speed 3: Canoe Chaos*
- *Speed 4: At Razor Scooter's Edge*
- *Face / Off 2: Face Back On*
- *Men In Black 5: Men In Turquoise? Yeah? Maybe Try It Out? See How It Looks?*
- *Terminator 7: Transition Lenses*
- *Spider-Man 14: Web of Lies*
- *Apollo 13 Two: Apollo 14*
- *Apollo 14 Two: Apollo 15*
- *Apollo 15 Two: Apollo's Creed*
- *Mission: Possible*
- *Mission: Achievable*
- *Mission: Attainable*
- *Mission: Feasible*

SEC. 46W—WELCOME TO BUD LIGHT, NJ

Bud Light will formally request that the town of Budd Lake, NJ be legally changed to Bud Light, NJ for the duration of Summer 2021. Should the town council formally approve this request, all Bud Light, NJ residents will receive discounted Bud Light beer

B.L. 1982—51

or Bud Light Seltzer through Labor Day. Wearing of cargo shorts shall immediately render this null and void.



FIGURE Y

SEC. 47—BEER BUCKETS

Per THE BEER BUCKET ACT OF 1879, whenever bar patrons order a “bucket of Bud Lights,” the beer MUST be in bottles or cans, and not simply a bucket filled with 5 gallons of Bud Light draft.

SEC. 48—HOT ENOUGH FOR YA?

A proposal to designate time-out corners at all summer parties for any and all persons who say, “Hot enough for ya??” in reference to the weather. Corner should be as far away from other partygoers and Bud Light as possible, perhaps even inside a garage, basement, or panic room.

SUBSECTION 4Y-1: If temperature is above 110 degrees, you are legally obligated to respond with, “It is now, Timmy.”

SUBSECTION 4Y-2: If party is taking place

B.L. 1982—52

in a pied-à-terre, ask yourself (a) what's a pied-à-terre again? and (b) why are there so many mimes here? If you answered "a delicious type of pastry" to the first question, proceed to the nearest patisserie and say, "*Péter plus haut que son cul.*"

SEC. 49—SUMMER BLOCKBUSTER SUGGESTIONS II: THE SEQUEL

Bud Light approves the enjoyment of Bud Light beverages while watching any of the following imaginary summer blockbuster film sequels:

- *Independence Day 3: Aliens Cross the Delaware*
- *Independence Day 4: Was George Washington an Alien This Whole Time?*
- *Independence Day 5: The British Return And Turns Out They Were Also Aliens This Whole Time*
- *Dirty Dancing 3: Let's Be Real This Was Never Just About Dancing*
 - *Speed 3: Bicycles Can Be Fast Too*
 - *Titanic 2: The Iceberg's Revenge*
 - *Titanic 3: 3 More Icebergs*
 - *Titanic 4: The Iceberg Isn't Done Yet*
 - *Titanic 5: Climate Change Versus the Iceberg*

SEC. 50-PU—JACUZZI BUBBLES

Bud Light supports any and all efforts to permanently ban from summertime hangs the producers of any bubbles arising in a hot

B.L. 1982—53

tub that do not come from the jacuzzi jets. You know what we're talking about, Steve. Come on. You know.

SEC. 51—THIS SECTION HAS BEEN REDACTED PER THE OFFICE OF UNIDENTIFIED SPACE THINGS

[REDACTED]

Bud Light is 100% supportive of any and all lifeforms from outer space (see 'Bud Light Area 51 Cans' 9.13.19). [REDACTED]

[REDACTED]

B.L. 1982—54

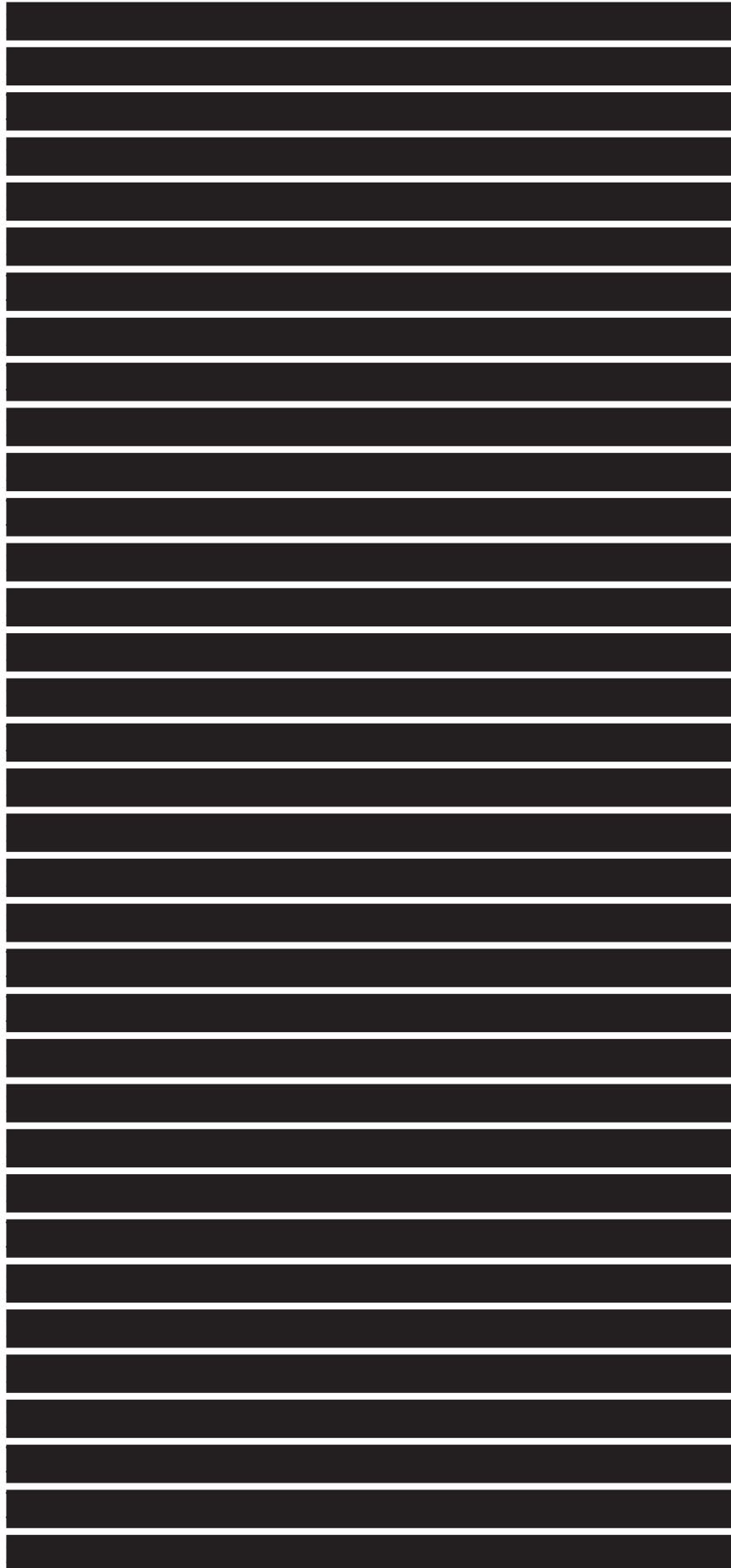

B.L. 1982—55

[REDACTED]

[REDACTED] Should aliens appear at your summer barbecue, Bud Light wants you to welcome them with free beer and food. [REDACTED]

[REDACTED]

B.L. 1982—56

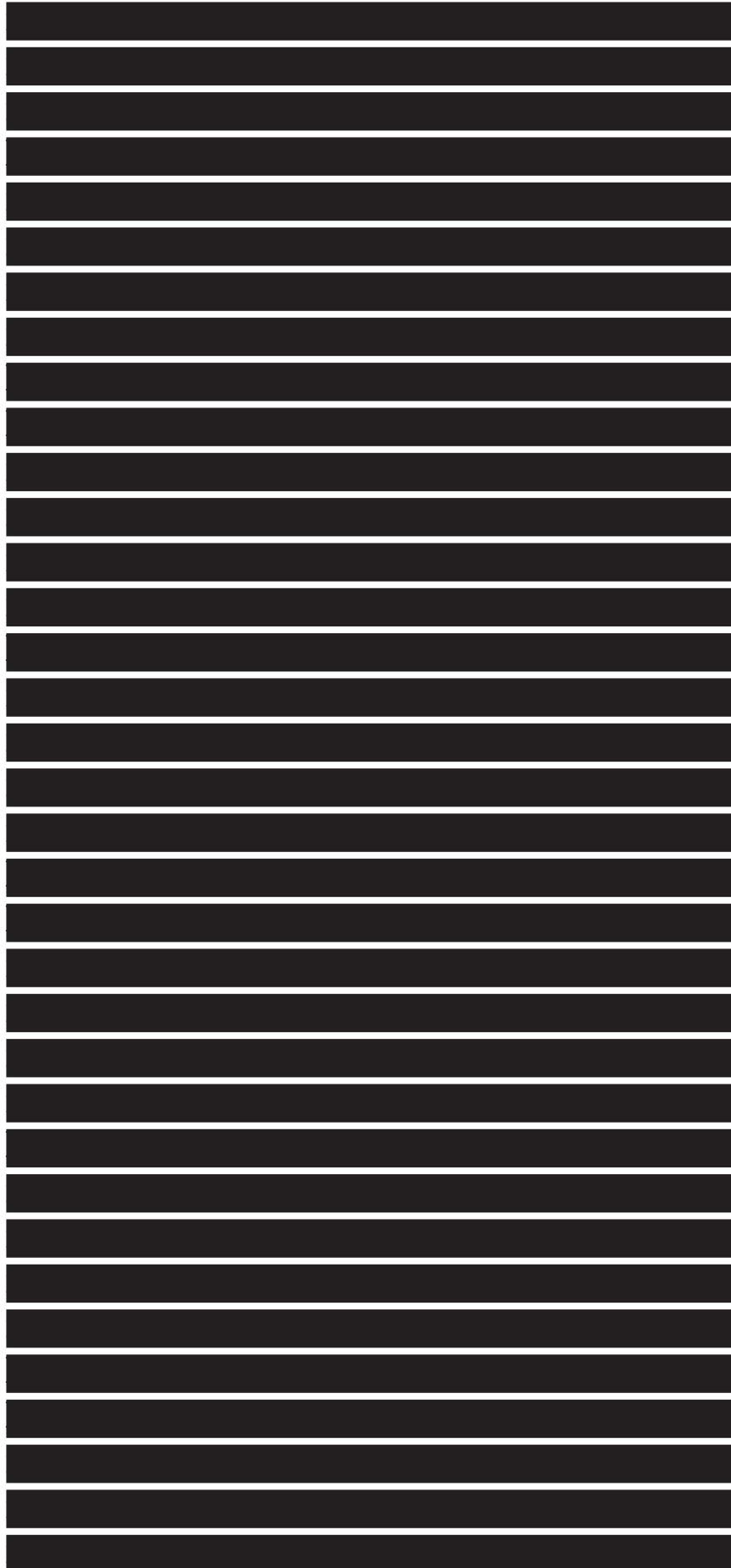

B.L. 1982—57

[REDACTED]

[REDACTED] Please note that hot dogs are generally bad for ALIENS, as is chocolate.

[REDACTED]

[REDACTED] No, wait, that's dogs. [REDACTED]

[REDACTED]

Okay, serve the aliens whatever you want, and remember to pet them frequently and take them for walks three times a day. [REDACTED]

[REDACTED]

B.L. 1982—58

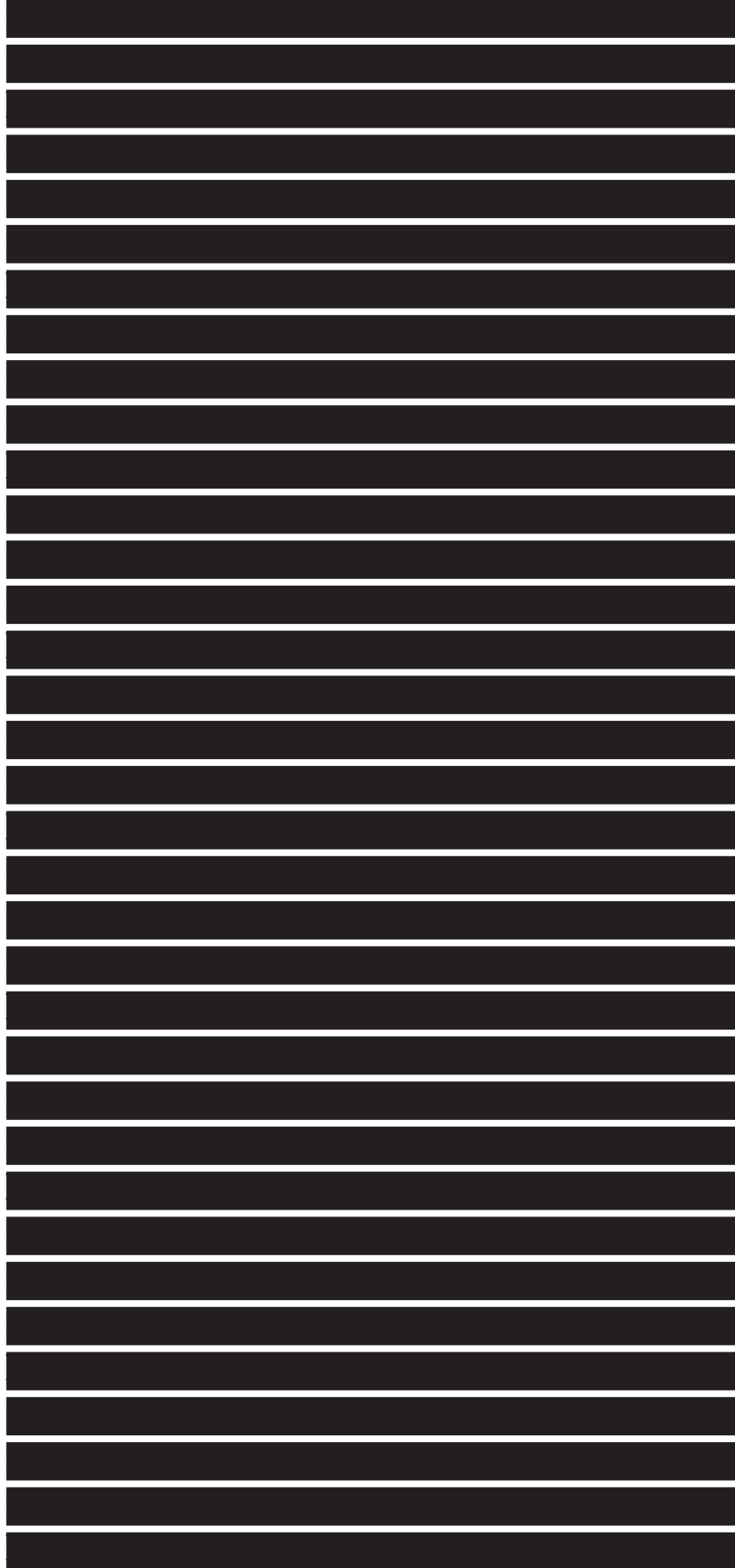

B.L. 1982—60

[REDACTED]

Earth

[REDACTED]

[REDACTED] Sun Mercury Venus

Mars Jupiter Saturn Uranus Neptune

Pluto

[REDACTED]

[REDACTED]

[REDACTED]

[REDACTED]

[REDACTED]

[REDACTED]

[REDACTED]

[REDACTED]

[REDACTED]

[REDACTED]

[REDACTED]

[REDACTED]

[REDACTED]

[REDACTED]

[REDACTED]

[REDACTED]

[REDACTED]

[REDACTED]

[REDACTED]

[REDACTED]

[REDACTED]

H C N O P

B.L. 1982—61

1 6 7 8 15

SEC. 52—TROPICAL SHIRT-WEARING HIPPO PHOTO FILTER

Bud Light hereby challenges all photo-creating and photo-sharing app platforms to produce a unique filter that turns everyone into tropical shirt-wearing hippos engaged in a fun game of volleyball. Or maybe badminton. Their call.

SUBSECTION A7: Funding may be pulled if platforms encourage the use of **#BudLightAreYouHippoToIt.**



FIGURE Z

B.L. 1982—62

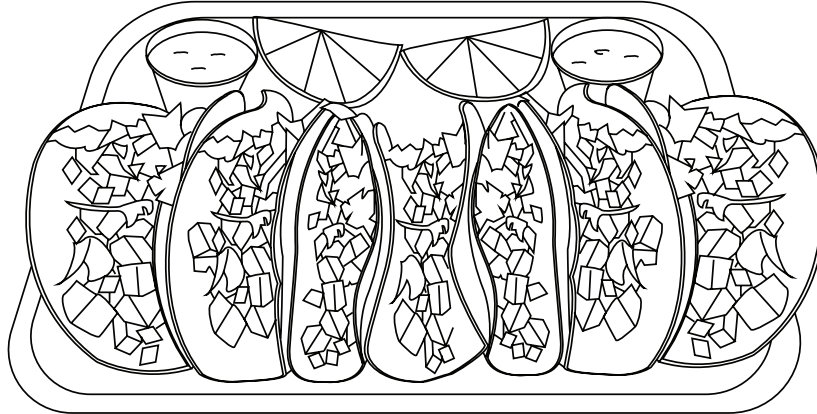

FIGURE ZZ

SEC. 53—TACOS!

For the month of May, Bud Light is proposing that Taco Tuesday be extended to any day that ends in -ay. Pursuant to the enjoyment of the aforementioned tacos, we are providing the following taco recipe that has been deemed ‘fire.’

BUD LIGHT TACOS INGREDIENTS:

- 2 tablespoons canola oil
- 2 tablespoons lime juice
- 3 cloves garlic, minced
- 2 teaspoons chili powder
- 1 teaspoon dried oregano
- 1 teaspoon ground cumin
- 1 1/2 pounds skirt steak, cut into small pieces
- 12 mini corn tortillas
- 3/4 cup red onion, diced
- 1/2 cup cilantro leaves, chopped
- 1 lime, cut into wedges
- 1 Bud Light, perfectly chilled

B.L. 1982—63

DIRECTIONS:

(1) Combine lime juice, 1 tbsp. canola oil, garlic, chili powder, cumin, and oregano.

(2) In large bowl, combine mixture and steak; marinate for at least 1 hour (up to 4 hours), turning occasionally.

(3) Heat remaining 1 tbsp. canola oil in a large skillet over medium-high heat. Add steak and marinade, and cook, stirring often, until steak has browned and marinade has reduced, about 5 minutes.

(4) Serve steak in tortillas, topped with onion, cilantro, and lime.

(5) Crack open an ice-cold Bud Light and enjoy.

SEC. 54—WOOL BEANIES IN SUMMER

Bud Light proposes that WOOL BEANIES may only be worn during summer if one is consuming ice cream, as studies have shown that in 90% of cases wool beanies are effective in preventing brain freeze. However, if you see someone wearing a wool beanie while eating LOBSTER-FLAVORED ICE CREAM, grab the 'ice cream' from them, hand it to the nearest 'dog,' and drive them IMMEDIATELY to the nearest 'hospital' as their brain is already showing signs of neurotrauma and poor decision-making.

B.L. 1982—64

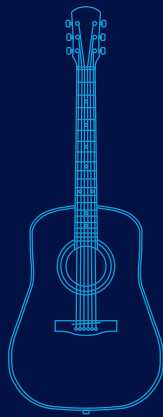

PART III—GRATIS MUSIC

B.L. 1982—66

**Subtitle A—
Turn It Up To 11**

**SEC. 55—CONCERT TICKETS ON
US!**

Bud Light recognizes how much you've missed live music over the past year. That's why Bud Light is bringing live music back to the people, or rather bringing the people back to live music by providing a shipload of tickets (henceforth referred to as a 'BOAT-LOAD') to your favorite music venues around the country. ALL. SUMMER. LONG. More to come from us this summer!

B.L. 1982—67

**Subtitle B—
More “More More Awesome-
ness”**

SEC. 56—THE STIMMY SHIMMY

Bud Light proposes that the official Hot Dance of Summer 2021 be THE STIMMY SHIMMY. Unfortunately, we’ve been so focused on our legislative duties that we haven’t had time to quite figure out what the dance actually consists of. So...we were kinda hoping you, AMERICA’S AWESOME DANCERS, could. Post your own **#BudLightStimmyShimmy** and take your shot at creating this summer’s hottest dance.

SEC. 57—BUD LIGHT CANS CANS

Bud Light calls on the nation’s audio industry (henceforth referred to as “Big Audio”) to create and mass-produce ‘Bud Light Cans Cans,’ aluminum-accented over-the-ear headphones (known as “cans” to anyone who’s anyone) that use Bud Light or Bud Light Seltzer aluminum cans to offer superb, balanced, high-fidelity audio while also providing listeners with superb, balanced*, high-quality ice-cold beer via flexible straws that go directly into the listener’s mouth, a la those classic beer can hats we all know and love that were purportedly invented by Thomas Edison, per a formal Presidential request from Abraham Lincoln.

B.L. 1982—68

AUDIOPHILES: We want this now, Bud Light!

AUTOMATED RESPONSE: Hold your horses, [AUDIOPHILES]

BUD LIGHT LAWYER: Please do not actually hold your horse. Unless you are indeed on a horse, then, yes, hold on for dear life. But make sure you're holding the reins and not that pretty tuft of fur (or is it hair on horses? I think it's hair) because that wouldn't be very nice, now would it? Bud Light's got your back, horses of America! (No surprise there.)

**The cans are basically balancing on your head.*

SEC. 58—HERETOFORE VS. HENCEFORTH

It has come to our attention that we may have been improperly using the terms HERETOFORE and HENCEFORTH between Sections 1 and Sections 58, which begs the question: Why didn't someone bring this up sooner? Why'd you let us go 58 (!) sections before saying anything!? Wait, was I on mute that whole time?!

SUBSECTION A: Henceforth, people need to give us a heads up!

SUBSECTION B: Or is it, Heretofore, people need to give us a heads up?

SUBSECTION C: And what about Hereafter?

SUBSECTION D: Or Hereunto?

SUBSECTION E: Do those have a place in this story?

B.L. 1982—69

SEC. 59—FINGER FOODS

In accordance with the National Finger Food Council and Asst. Secretary of Snacking, the following foods are recommended and approved for holding in one hand while holding a Bud Light with the other:

- (1) Hot Dogs
- (2) Hard-Boiled Eggs
- (3) Pretzels
- (4) Donuts (mmm...donuts)
- (5) Knishes
- (6) Apple Fritters
- (7) Kebabs
- (8) Donuts
- (9) Spring Rolls
- (10) Pizza
- (11) Donuts
- (12) Sandwiches
- (13) Corn Dogs
- (14) Chicken Fingers
- (15) Hand Pies (yeah, you better believe those are a thing)
- (16) Burritos
- (17) Tacos
- (18) Calzones
- (19) Anything on a SKEWER (Great word. Say it aloud with me: "Skewer." Feels good, right?)
- (20) Donuts
- (21) Quesadillas
- (22) Lamb Chops
- (23) Egg Rolls
- (24) Donuts
- (25) Ice Cream Cone (ice cream is a food, right?)

B.L. 1982—70

- (26) Pastry Pockets
- (27) Sliders
- (28) Sausage Rolls
- (29) Empanadas
- (30) Donuts
- (31) Bread Sticks
- (32) Churros (maybe more fun to say than skewers)
- (33) Dumplings
- (34) Pizza Pockets
- (35) Chicken Wings
- (36) Papadums!

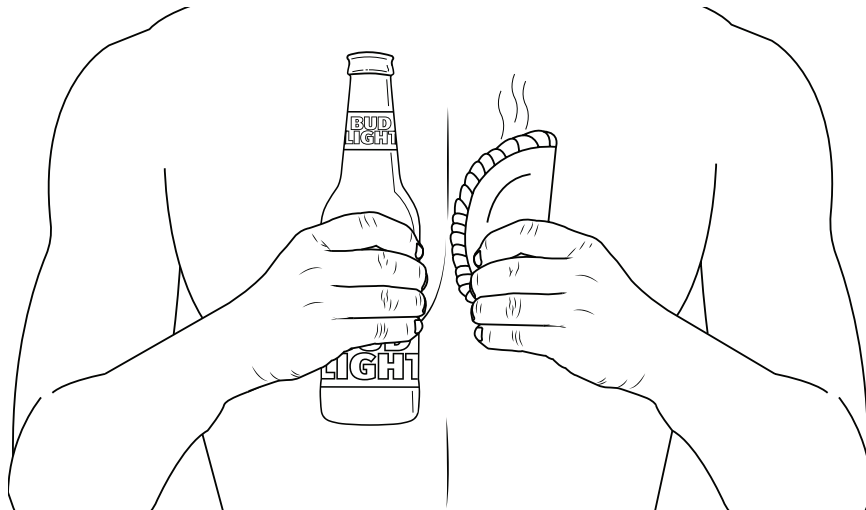

FIGURE ZZZ

SEC. 60-93.5—THAT’S MY SUMMER JAM

Bud Light proposes that all summer jams should be played at a volume that will make people go, “Wow it’s summer and I’m jamming!”

ADDENDUM—Dance move of the summer (not to be confused with the Hot Dance of

B.L. 1982—71

Summer 2021; see Sec. 56—THE STIMMY SHIMMY) shall be easy enough for everyone to attempt to do in public. Dance move shall avoid putting too much strain on one's knees or require too much learning of intricate choreography. Dance moves shall ensure that you look like the life of the party.

SEC. 61-90S—TIMELESS BANGERS

To keep the party rocking across generations, all Summer 2021 playlists must be composed of no less than 20 percent nineties songs and are legally required to include the following genres: grunge, hip-hop, riot-grrrl punk, and grunge.

SEC. 62—COMMITTEE ON ACOUSTIC AFFAIRS

The Committee puts forward THE BEACH CAMPFIRE SINGALONG PREVENTION ACT, which states that upon successful building of any campfire this summer, people with any of the following names are hereby discouraged from breaking out their acoustic guitar and insisting on leading the group in an unrequested singalong:

Adam
Azalea
Mason
Autumn
Meadow
Hunter
Crystal

B.L. 1982—72

Logan
Brad
Chad
Bradley
Chadley
Saffron
Ethan
Aurora
Zora
Dora
Tanner
Tucker
Aiden
Jaden
Caden
Chip
Skip
Flip

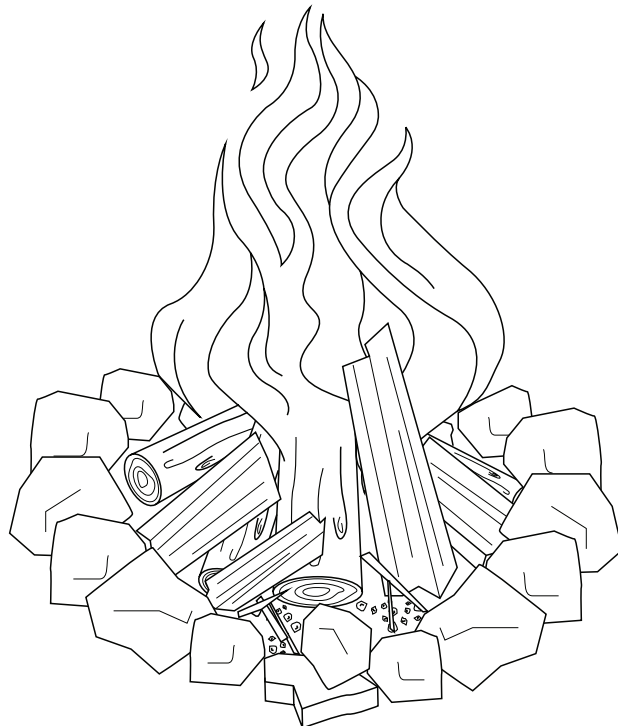

FIGURE !

B.L. 1982—73

Serenity
Noah
Cloud
Cody
Brody
Toby
Blake
Alex
Astrid
Cam
Bryce
Harper
Willow
Pillow
Leif
Leaf
Carter
Ian
Spencer
Reid
Perry
Chase
Everett
Luna
Moon
Tate
Jude
Brooks
River
Graham
Hudson
Judson

B.L. 1982—74

SEC. 63—FEDERALLY APPROVED DOG SONGS

If while drinking a Bud Light in your yard on a beautiful summer evening, you feel compelled to sing to your dog, the following songs are approved and deemed appropriate for all of the nation's dog breeds...barring Golden-doodles.

FEDERALLY APPROVED DOG SONG 1

*Snuggly McRuffers and I'm here to say
Won't you be my snuggly doggy today
Snuggly McRuffers and I'm here to say
Won't you be my snuggly doggggggggy
Toooo-day, today, today*

FEDERALLY APPROVED DOG SONG 2

*Muy muy muy muy muy perrito
Muy muy muy oh yeah
Muy muy muy muy muy perrito
Muy muy muy oh yeah
Oh yeah, oh yeah, oh yeah*

FEDERALLY APPROVED DOG SONG 3

*Excuse me for being super cuddly
Excuse me for being super snuggly
Excuse me for being a heckuva dog
Buddupa ba buddupa*

SEC. 65-J5—RANDOM BRAIN TEASER

To keep your mind sharp this summer, please extrapolate a classic pop song title from the following:

- (A) It's (I.)
- (B) easy (II.)
- (C) as (III.)

B.L. 1982—75

SEC. 66—EULOGY/ELEGY FOR YOUR SUMMER TAN

Bud Light recognizes that the end of summer is inevitable and hereby proposes the following eulogy (or is it an elegy?) be used to bid farewell to your summer tan:

Today we say farewell to a beloved friend and devoted advocate for baring your legs in public: Your Summer Tan, who faded and peeled away after a long battle with SPF 50.

To everyone else, your Summer Tan was known as a “glow up.” But to you, your Summer Tan was more than just a tan, it was a mentor, a friend, and above all, a lifestyle.

Summer Tan made several contributions over the course of its brief existence on your epidermis. Summer Tan helped give you the confidence needed to pull off tank tops, shorts, and sandals, as well as dance in public like no one’s watching—yes, your Summer Tan was able to do all that, thanks to the sheer power of its base tan. Summer Tan made everyone feel like a Greek Goddess or the kind of person who hangs out on a boat all day. Summer Tan made you look really great in white clothes.

Your Summer Tan’s only regret was that they didn’t get a chance to see you in your new red swimsuit. Its other regret was that you never learned French.

If Summer Tan’s life has taught us anything, it’s that we should embrace the season of summer, and to have as much fun as possible, for summer is fleeting, but the pallor of

B.L. 1982—76

winter skin is long.

Your Summer Tan is survived by their relatives: Farmer's Tan and Really Bad Sunburn.



FIGURE ©BUDLIGHT

SEC. 67-BBQ—THE GRILLMASTER

When attending a family BBQ, the host shall be addressed by the venerable title of ‘GRILLMASTER.’ Party guests shall speak in hushed, reverent tones when in the vicinity of the grill, hereafter referred to as ‘HIS/HER PRIDE AND JOY.’ Guests shall respectfully sip Bud Lights while listening to the GRILLMASTER’S monologue in which he/she reveals the backstory to his/her secret sauce and the pros and cons of using wood chips versus charcoal. Under no circumstances shall anyone attempt to eat the foodstuff emerging from His/Her Pride and Joy while

B.L. 1982—77

Grillmaster is discussing any of the above.

SUBSECTION LO-SLO—At no point should the grill be referred to as ‘the barbecue,’ e.g., “Honey, start up the barbecue while I marinate the chicken breasts in Italian dressing.” NO! That type of language will not be tolerated. It’s a grill, people! Just a grill. Cooking food over fire. That’s GRILLING. Back us up, Texas. We know you’re with us, KC.

SEC. 68—THE BUD LIGHT BURGER COOKING GUIDE

Uncooked (0°F to 32°F)	Tell Cody to please turn the grill on before cooking.
Rare (120°F to 125°F)	Tell Cody to have Dr. Gibson on standby.
Medium Rare (130°F to 135°F)	You live on the edge, but in a suburban way.
Medium (140°F to 145°F)	The height of summer pleasure. Just add cheese.
Medium Well (150°F to 155°F)	Fine, I guess, but why not just man up and stop at ‘Medium’ next time?
Well Done (160°F to 165°F)	If you want to eat rubber, just say so. Don’t insult the grill with this nonsense.
Insanely Well Done (180°F to 185°F)	Cody has gone AWOL from his grill duties. Someone please check on the grill. And Cody.

FIGURE #

SEC. 69—FLIP FLOP SEASON PREP

To acclimate feet for the upcoming open-toe shoe and flip flop season, Bud Light proposes the following program be immediately enacted:

- Feet to be exposed to natural air for one hour per day, provided no other human being is within a 12-foot radius

B.L. 1982—78

- Feet to be exposed to sunlight, once a week, or until skin tone resembles that of a person who lives aboveground

- Feet to be soaked in hot water, until nails are no longer a threat to other humans

SUBSECTION FOR FOOT GNARLINESS:

(I.) For thick toenails, hedge clippers should do the trick.

(II.) For hardened heels, a pumice stone should be swiftly deployed.

(III.) For hairy toes... can't help you there.
See: CLOGS, HOBBITS

SEC. 70°—BUD LIGHT THERMOMETERS

Bud Light proposes to replace Standard Mercury Thermometer readings with the following less mathematically accurate, but more emotionally accurate, thermometer readings.

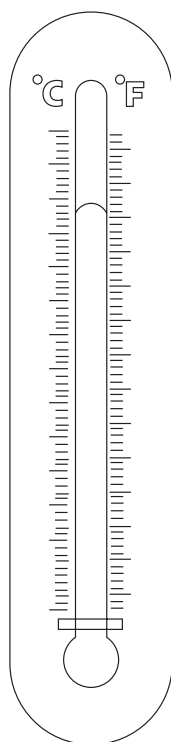

- 110° - F this, we're moving to Canada.
- 105° - Popsicle melts before it's even opened.
- 100° - Even shaded areas are like, "Damn, it's hot."
- 95° - So hot you can fry an egg on the sidewalk. That being said, please don't fry an egg on the sidewalk.
- 90° - Dogs panting. Humans also panting.
- 85° - Starting to sweat through clothes in 6–8 different areas of body.
- 80° - Hmmm. Okay. Still manageable, but let's watch it, alright?
- 75° - Aggressively comfortable.
- 70° - Totally cool. Temperature-wise and, like, how people say, "It's totally cool."

B.L. 1982—79

SEC. 71-H2OMG—BELLY FLOPS

Bud Light encourages people to not feel embarrassed or ashamed by any tummy burns resulting from the act of jumping into a pool and accidentally belly flopping. But do feel free to feel embarrassed by your abnormally small big toe.

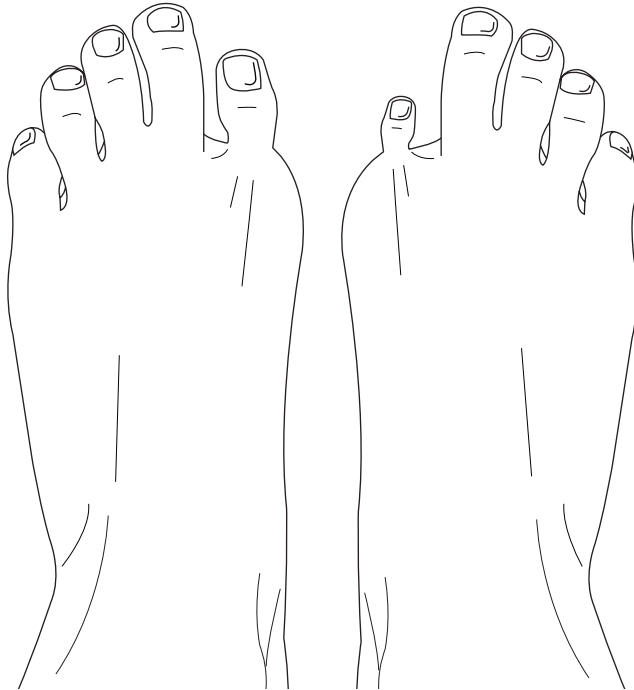

FIGURE \$

SEC. 72—DOG PLUS-ONES

Dogs should henceforth be allowed and welcomed as a plus-one to all picnics, barbecues, shindigs, bridal showers, weddings, masquerade balls, museum openings, seances, cast parties, cat parties, statue dedications (especially if it's a dog statue), and boat dedications. When greeting a 'dog plus-one,' it is customary to shake their right paw. (Shaking the left paw can be construed as an act

B.L. 1982—80

of aggression and, in some breeds, an act of war.) A good tip for remembering their name is to immediately say it aloud twice while shaking said paw. “Mary Puppins! Well, the pleasure is all mine, Mary Puppins.”

BUD LIGHT LAWYER: It is our strong recommendation NOT to bring a dog as a plus-one to a cat party.

ADDENDUM: Unless it’s a CATS PLAYING POKER party.

BUD LIGHT LAWYER: It is our strong recommendation NOT to play poker with cats.

SEC. 73-BLT—HEROS, HOAGIES, SUBS & SAMMIES

Any person who steals a sandwich (henceforth defined as a “sammie”) from another person while latter person is in any of the following acts of beach-related-fun...

- (A) splashing in the ocean waves
- (B) attempting to ride a ludicrously under-sized boogie board
- (C) trying to balance on an adorable flamingo pool floatie that has no business being in the open water
- (D) getting buried in the sand
- (E) playing volleyball
- (F) tossing frisbee while also playing volleyball
- (G) building a sandcastle/foxhole/moat
- (H) searching for seashells by the seashore
- (I) searching for seashells by the seashore
- (J) searching for seashells by the seashore

B.L. 1982—81

(K) checking out a cool piece of driftwood

(L) having a life-changing chat with the old guy selling saltwater taffy

...shall be subject to double the punishment by the [food] courts because Bud Light believes all persons engaging in said act(s) of fun in Summer 2021 shall feel safe to leave heros, hoagies—heck, even gyros—tucked deep in a shoe and/or hidden under the ice pack in the cooler without fear of theft.

SEC. 74—WATERMELON ERGONOMICS

Bud Light humbly requests that THE WATERMELON COUNCIL put forth a measure to improve the ergonomics of watermelons to enable easier carrying of watermelon under one's arm, especially if you're bringing the watermelon to a party and expect to see your crush there. Watermelons should also be easier to cut into so that a person does not have to worry about accidentally slicing off a finger, since losing any appendages can be a major buzzkill at parties, especially if this is done in front of your crush. And while you're at it, anything you can do to make watermelon seeds less easy to accidentally swallow—I've swallowed 17 since the beginning of this section—would be much appreciated.

SEC. 75W—BUD LIGHT LIGHTS

Bud Light proposes recycling your empty Bud Light cans by turning them into something you can use all summer long: outdoor

B.L. 1982—82

backyard lights to light up your summer evenings of enjoying Bud Light with your friends. The following steps will help you get started:

STEP 1: Buy a case of Bud Light cans.

STEP 2: Invite your friends over and crack open some Bud Lights.

STEP 3: Remind Larry not to crush any Bud Light cans.

STEP 4: Every time a guest finishes their beer, challenge them to see how fast they can wash the can. Tell them the fastest person will get a prize.

STEP 5: Once your friends have washed all the cans, tell them you have an early squash match in the morning and send them home. If someone mistakenly thinks you said that you have an early “SASQUATCH” in the morning, just roll with it.

STEP 6: If someone asks about the prize for fastest can cleaning, tell them you don't remember saying that.

STEP 7: Gather the cleaned Bud Light cans. Hug them if you like. No one's around. Goddammit, Larry's still here, looking at you oddly. Tell him you have an early squash match with Sasquatch in the morning.

STEP 8: Poke holes in the sides of each Bud Light can. Don't worry, they can't feel any pain. They're just cans, silly!

STEP 9: We lied about the Bud Light cans feeling pain. That poking did indeed hurt them...emotionally.

STEP 10: Go to the basement to look for festive lights. You'll be stringing them through

B.L. 1982—83

the Bud Light cans.

STEP 11: Avoid the scary corner with the flickering light bulb.

STEP 12: If you can't find them, head back upstairs. Crikey, Larry's still here! Feel free to say, "For crying out loud, Larry. You scared the crap out of me."

STEP 13: Head upstairs to the attic.

STEP 14: Avoid scary corner with the flickering light bulb...above the rocking chair with the doll in it. Wait, was that chair rocking before?

STEP 15: Run screaming out of the attic.

STEP 16: Go to ALUMINUM MAGIC'S on-line shop.

STEP 17: Find "Bud Light Can Lights."

STEP 18: Purchase them, along with an adorable scented Bud Light Can-dle.

STEP 19: Gently put a blanket over Larry on the couch, and head up to bed.

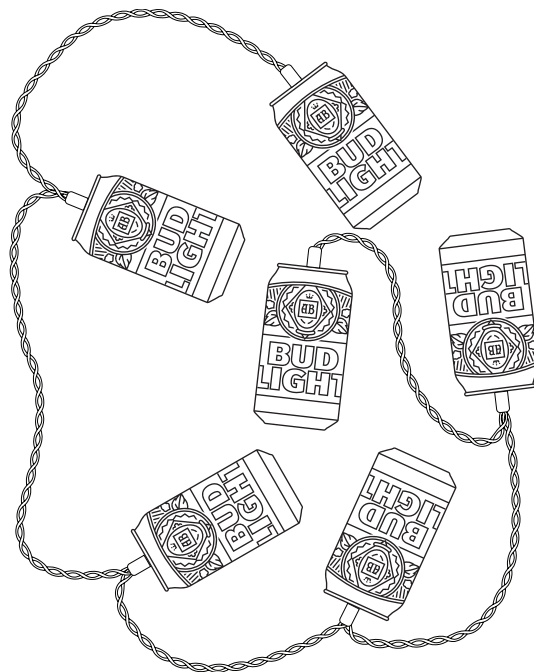

GO FIGURE!

B.L. 1982—84

SEC. 75.6.20—SHARK PEACE TRUCE

To ensure the quality and safety of our beachgoing experience, Bud Light hereby declares a summertime peace agreement between humans and sharks, with the following provisions:

- Sharks to avoid baring their teeth and sneaking up on any swimmers, surfers, paddleboarders, etc. and instead will clearly announce themselves, preferably in a British accent
- Humans to avoid looking too appetizing
- Secretary of Summer and shark fanboy Gronk to teach no less than five (5) sharks how to catch a football without popping it with their teeth

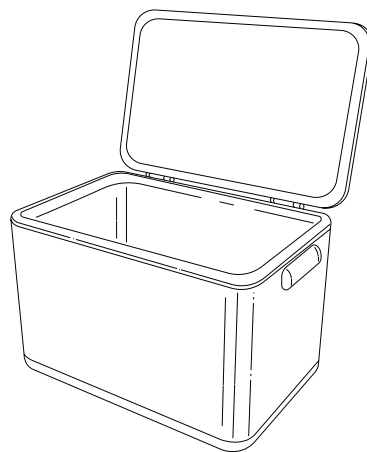

FIGURE %

SEC. 78—FREE COOLERS!

To ensure that people's Bud Lights remain between 42 and 48 degrees Fahrenheit ALL SUMMER LONG, Bud Light will be giving away Bud Light Coolers ALL SUMMER LONG.

B.L. 1982—89

Query 3: Speaking of monsters, are any precautions being made should a Giant, a Colossus, or a Leviathan emerge from the earth, sea, or other dimension and believe this enormous cooler is just a regular cooler for her or him to fill with enormous cold cans of Bud Light?

This press conference is over! [walks away flustered and genuinely frightened]

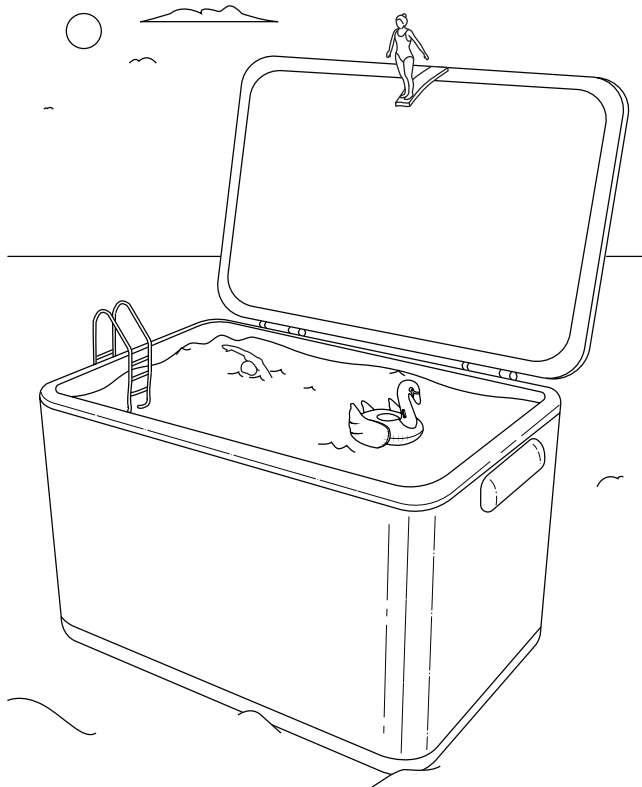

FIGURE ^

SEC. 80S—BEE STINGS & FORMER BRITISH POP STARS

If you're stung by a bee this summer, instead of cursing—which, frankly speaking, is

B.L. 1982—90

rather predictable—Bud Light recommends you belt out a relevant lyric from a song by the one-word 80s British pop star named after what a naughty bee does. Just alter the lyrics a wee bit to match your current situation...and prevent us from getting sued.

SEC. 81—BUD LIGHT: THE MOVIE

Bud Light will rent out 10 movie theaters or drive-ins around the country for 90-minute parties airing the summer's biggest blockbuster, *Bud Light: The Movie*. Ninety heart-stopping minutes of a beauty shot of Bud Light on screen, while you and your friends drink Bud Light and Bud Light Seltzer from Bud Light coolers.

DELICIOUS SUBSECTION: You better goddamn believe popcorn will be provided.

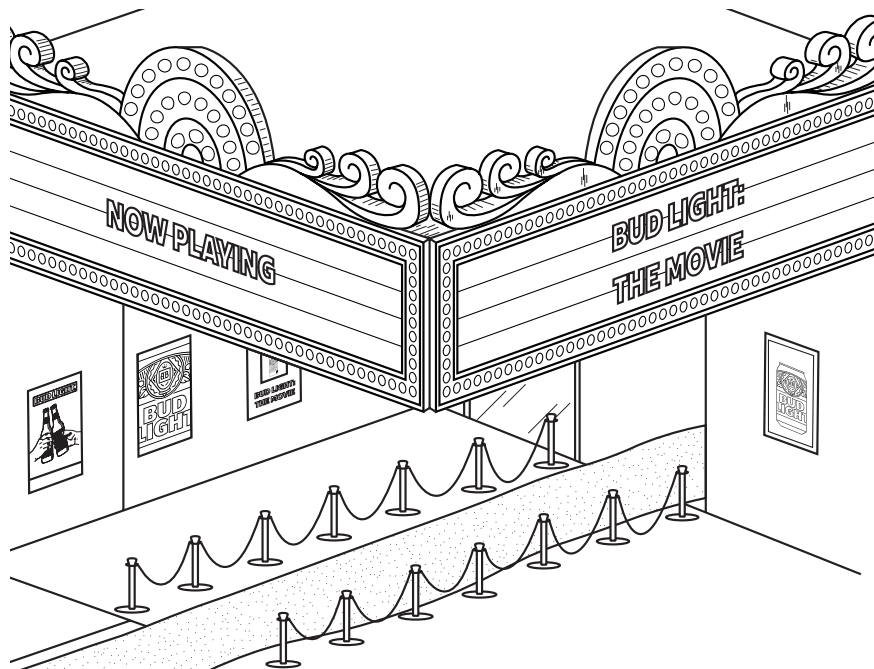

FIGURE &

B.L. 1982—91

SEC. 82—SURF SATCHELS

Bud Light recognizes that carrying personal belongings to the beach can be challenging for men. (“Personal belongings” can include, but are not limited to, the following: mobile phone, earbuds, wallet, sunglasses, e-reader, a sweet rabbit’s foot keychain, and a mini cheese wedge.) Bud Light further recognizes that some resourceful men resort to collecting and carrying said belongings in a small beach-friendly bag or pouch. These bags or pouches are henceforth to be termed ‘SURF SATCHELS.’ Not MAN PURSES, despite what your friends or the MAN PURSE ACT OF 1998 might tell you.

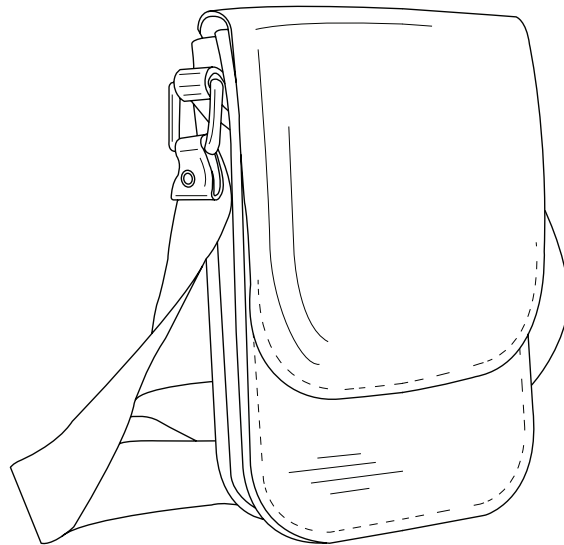

FIGURE ***

SEC. 83—DOUBLE-CHUCK

Should any person or persons call out to another person or persons with the specific phrase, “Hey, toss me a cold one,” (see sub-

B.L. 1982—92

section iv at the end of this section for definition of what does and does not constitute ‘a cold one’) it’s understood that said “toss” shall be a light, underhand throw, made in conjunction with proper eye contact between the tosser and the tossee.



FIGURE 1

(I.) However, should someone say, “Hey, brah, whip me a cold one,” the person of whom the “whip” request was made shall not feel any hesitation to throw said cold one overhand, with increased force, with the understanding that the requesting party is sufficiently prepared to receive said ‘cold one’ at a high, unencumbered velocity.

(II.) Should one ask the person nearest said ‘cold ones’ to “Pop me a cold one,” this is

B.L. 1982—93

merely a request that the cold one be opened, and requesting party shall approach opened cold one themselves in a timely manner, thus absolving popper of any obligation to deliver said 'cold one.'

(III.) If one should say to person nearest cooler of 'cold ones,' "Hey Chuck, chuck me a cold one," and that person nearest cooler of 'cold ones' is named Chuck, it is understood that the person who uttered the DOUBLE-CHUCK should be asked to stand in the corner for 10 minutes and think about what they've done.

(IV.) As first termed by the Founding Fathers, 'a cold one' is just another way of saying 'an ice-cold Bud Light.'

SEC. 84—POOL NOODLES

Bud Light would like to honor the valiant pool noodles of America for keeping our nation's adults afloat in water. Thanks to these brave noodles, Americans have long been able to pretend to ride a seahorse, "swim" in the ocean without having to extend any physical effort, and look ridiculous all summer long without expending any effort.

Subsection 84-A: Henceforth, ALL pool noodles shall be honorably relieved of their duties and responsibilities when a couple chunks of foam fall off.

SEC. 85—FIREFLIES

Request to add the following rider to THE CATCHING FIREFLIES ACT OF 1958: In order to make this summertime pastime

B.L. 1982—94

more fair and equitable, fireflies shall henceforth also be allowed to catch humans in a jar. Per annum, on the first Tuesday after Memorial Day, human-sized jars are to be provided at fields, meadows, and wherever humans like to frolic at night and sip their Bud Lights. Humans are to wear bright, shimmery clothing to attract the attention of fireflies. We should also absolutely remember to poke holes on top of the jars to allow humans to breathe.

SEC. 86—BEARS

Full disclosure: This section is not a proposal. Nor is it an addendum, or any other sort of legislative act. (As long as we're being honest here, since this section seems like a safe space: We actually have no idea what an addendum even is. Um, do you? If you do indeed know, or even if you just have some vague ideas about what one is, please let us know. Is it a type of plant, like a philodendron? Don't people have house addendums that always die because they don't water it enough? Or is it because they overwater it? That's stupid. Now I remember. It's a type of marsupial, right? Like a...possum or something? SAFE SPACE! SAFE SPACE! SAFE SPACE! NO JUDGING! IT'S NOT A VERY COMMON WORD!) Um, what just happened? Anyway, we saw this nature documentary on BEARS and it really freaked us out. So this is just sound advice for anybody camping out in the wilderness this summer.

In The Event That One Is Out Camping

B.L. 1982—95

And Encounters A Bear, Consider Taking The Following Steps:

(1) Make yourself look as large as possible. You want to intimidate the bear.

(2) ADDENDUM* TO POINT 1: Actually, make yourself look as small as possible. You never want to intimidate the bear.

(3) Hike and travel in large groups. The increased noise will frighten bears away.

(4) Wait... Do NOT hike in large groups, unless you want the bear to attack you and all of your friends.

(5) Do not allow the bear to access your food.

(6) Unless that food is bow tie pasta. For some reason, bow-tie-pasta-loving bears don't attack. Calling on all zoologists to research why this is. Assuming it's because they like fancy attire.

(7) If a bear starts to attack you, bonk it on the nose and that will send the bear running.

(8) Just don't say the word "BONK" as you bonk the bear. Bears loathe onomatopoeia.

(9) NEVER, under any circumstances, scream at a bear.

(10) Unless those circumstances involve you asking if the bear wants to hang out sometime. When bears are asked to make plans, they feel flattered and begin to retreat.

(11) Point over the bear's shoulder and say, "Hey, is that a fish jumping out of the stream?" The moment the bear turns to look, run!

(12) Never run from a bear. A bear will al-

B.L. 1982—96

ways catch up to you and, before eating you, will mock you for thinking you could outrun her.

(13) Gather smaller friends to keep out of reach of the bear. Medium to large friends (hereafter referred to as “husky”) can fend for themselves.

(14) DO NOT pepper spray a bear. Bears love pepper. Duh. Everyone knows that.

(15) Hide in your tent. When bears see a tent in the woods, they usually think it’s just a tree that’s shaped kind of weird.

(16) Feel free to challenge the bear to a karate matchup. Most bears are a purple belt, at best.

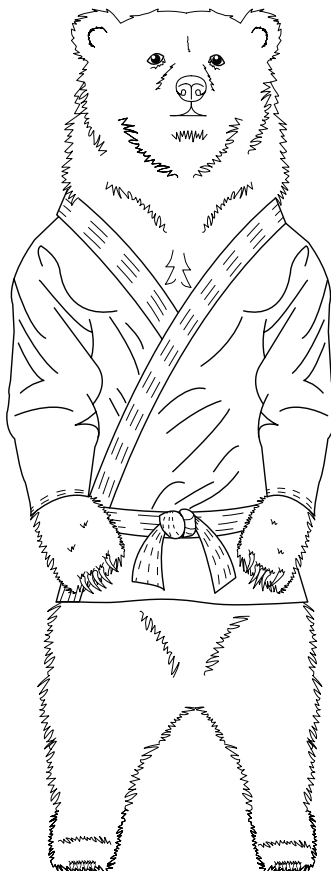

FIGURE 3

B.L. 1982—97

(17) Play dead. We recommend doing this with your eyes closed because if your eyes are open, you will have to blink at some point, and the bear will feel especially foolish for falling for it.

(18) Play dead. We recommend doing this with your eyes open because if your eyes are closed, the bear won't be able to tell if you're dead or just sleeping. That confusion will anger the bear, who will want to eat whatever is right in front of it, which in this case is you.

(19) Do say, "I'm so scared, I can't BARE any more danger!" Bears respond kindly to puns.

(20) BUD LIGHT LAWYER: Phrase should actually read: 'I can't BEAR any more danger!' Bears don't respond kindly to mistakes like that.

(21) (Stay in your lane, Bud Light Lawyer! That's not even a legal comment!)

(22) The most important thing is to STAY CALM and remember that this isn't a big deal—there's just a colossal 1,200-pound flesh-eating mammal standing inches away from you.

**HOUSE PLANT or POSSUM-LIKE MARSUPIAL. Is it possum or opossum? A question for the ages. And a great question to ponder over...a nice cold Bud Light. See how we brought that back to Bud Light?*

B.L. 1982—98

SEC. 87—RECIPE FOR BEN FRANKLIN'S POTATO SALAD

Pursuant to THE POTLUCK ACT OF 1983, passed in honor of Aunt Carol of Duluth, Minnesota, we hereby provide the original recipe of Ben Franklin's famous potato salad.

Subsection 1756—Ingredients:

- New potatoes
- Old potatoes
- Baby potatoes
- The potatoes with the weird little growths all over them (those weird bits are the best part!)
 - 10 pounds of mayo (no such thing as cholesterol in colonial times)
 - 10 pounds of salt (high sodium not a thing either)
 - Maize
 - Rust shavings from an old bifocal (great source of iron)
 - Chopped mutton, if you have some around the house
 - A little dash of sweat after a long, productive day inventing the lightning rod
 - 1 can or bottle of Bud Light (which was totally around during his time!)
 - More mayo (which he purchased at his local Ben Franklin store)

While the potatoes are boiling, write an entry in your almanac or brainstorm some ideas for a united postal delivery service. Afterwards, mix all the ingredients, while letting all of your brilliant ideas marinate. Best

B.L. 1982—99

enjoyed outside, while imagining what your face would look like on a hundred dollar bill.

SEC. 88—BEACH TOWEL SPREADING

Bud Light seeks funding to build a team of the nation's top astrophysicists to figure out how to make beach towels easier to spread out on a windy day. SUBSECTION 4CNRS: Beach Towel Spreader Abusers—you know who you are!—will be prosecuted to the full extent of the law.

SEC. 89—MOSQUITO BITE CEASEFIRE

In order to decrease the number of mosquito attacks on humans, the SECRETARY OF INSECTS THAT MAKE YOU GO “OUCH!” has declared a truce with America's mosquitos. Per the agreement, all humans should practice the following:

- Avoid wearing any fragrance that says “come hither” to mosquitos
- Paint their legs a rich mahogany or walnut so they look like table legs, not human legs
- If the truce doesn't hold, consider performing the classic “stand next to someone the mosquitos like more than you” to draw them away from your precious self

B.L. 1982—100

SEC. 90-99—GREAT MOMENTS IN 90S SUMMER PARTY HISTORY

Bud Light wishes to momentarily digress from the Summer Stimmy in order to pay tribute to the following Great Moments in 90s Summer Party History:

JULY 7, 1990—LINDSAY COZEN sets a New Jersey Limbo Record by going under a limbo stick that's only 1.5 inches above the ground.

AUGUST 18, 1992—CONOR MASON inhales helium from a balloon and accidentally ends up singing the most moving rendition of "Take Me Out to the Ballgame" that anyone has ever heard.

JULY 22, 1993—First and last-ever attempt is made to have a Wet Hat Contest.

AUGUST 21, 1995, 11:34PM—Milk Pong is introduced to the world.

AUGUST 21, 1995, 11:38PM—Milk Pong is never played again.

JUNE 13, 1996—Three beach balls stacked on top of each other and wearing a trench coat and sunglasses successfully sneak into a party at **COREY BROWN'S** town house without anyone noticing.

JUNE 4, 1997—First and last-ever attempt is made to have a Wet Cat Contest.

AUGUST 6, 1998—In San Diego, an entire party occurs with "Dude" being the only word spoken by every attendee for the party's duration.

JULY 28, 1999—In an attempt to do some-

B.L. 1982—101

thing “cool,” MICHAEL GOON leaves a Madison, Wisconsin party, steals a STOP sign from the street, returns to the party, and hangs the STOP sign on the wall. This backfires when everyone instantly stops partying.

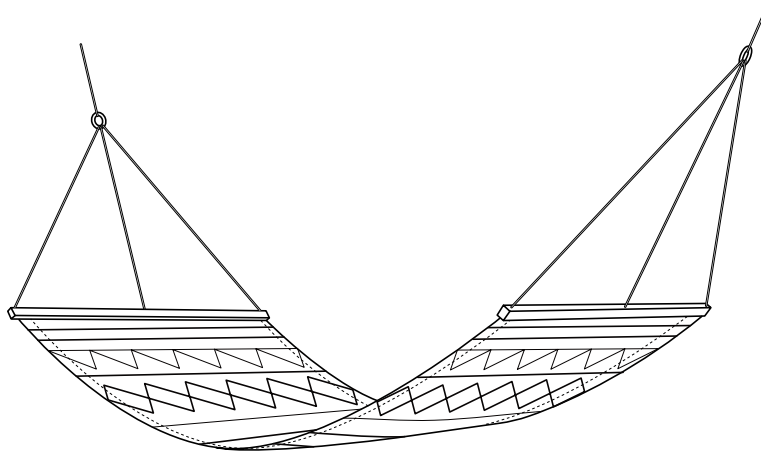

FIGURE 4

SEC. 1U1—HAMMOCK SAFETY

All pairings of trees within twelve (12) feet of one another shall be connected with biodegradable hammocks that will last throughout the summer and then fall and decompose along with the fall leaves, because Bud Light believes there is nothing better than a hammock in summer...and nothing sadder than a hammock in the dead of winter.

Addendum—Introduction of THE HAMMOCK ACCIDENT PREVENTION ACT. In response to the millions of injuries sustained by people attempting to get into—and out of—hammocks, Bud Light proposes the following actions be taken:

B.L. 1982—102

- Replace hammocks with chairs

SEC. 102—A BUNCH OF PIE CHARTS

Per Subsection 3.14159265358979323: What's better than pie? How about pie charts? Okay, so they're not better than pie—but they are funnier. At least these ones are. Unless you're talking about those shaving cream pies that people throw at one another's faces? Those are pretty damn funny. Unless...you're on the receiving end of one while in the middle of giving a speech to the U.N. Then that's not funny. That's just mean. Unless...the speech you were giving was about banning memes or banning kittens or banning kitten memes. Then you deserve that pie in the face. Wait, what were we talking about again? And isn't this document supposed to be legislative initiatives and proposals? Look, FUNNY PIE CHARTS!

B.L. 1982—103

SEC. 103—WHERE YOUR KEYS MIGHT BE AFTER A DAY AT THE BEACH

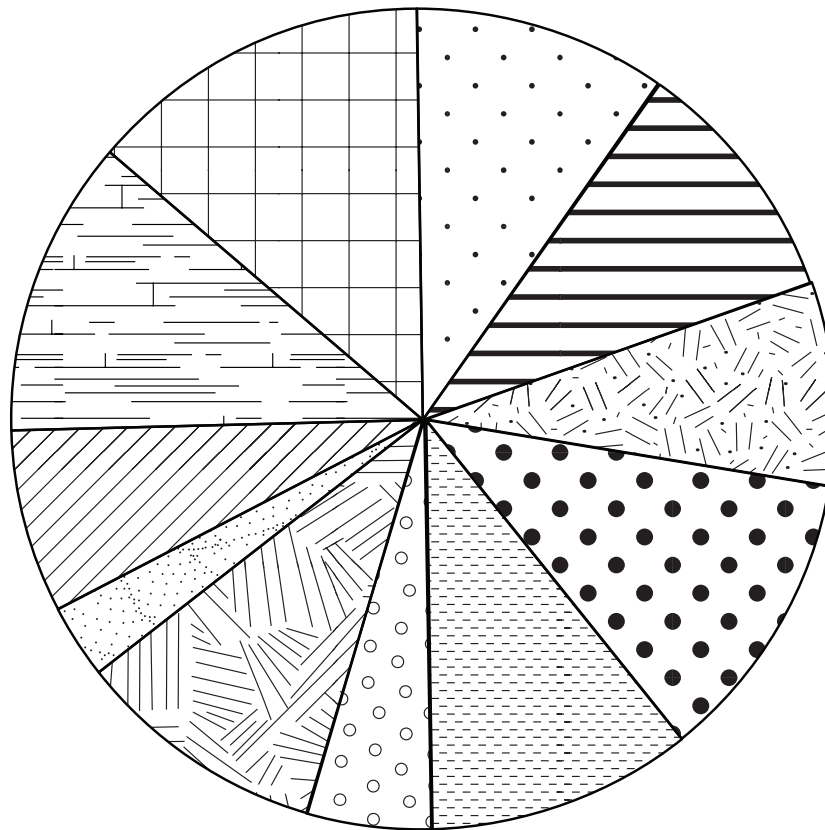











-  Inside a shoe someone else wore home
-  Beach bathroom (zero percent chance of going in there again)
-  Hidden bathing suit pocket
-  In the shorts in your trunk
-  In the trunk in your shorts
-  In the moat of a sand castle
-  With Doug (classic Doug!)
-  Key Heaven
-  Sewer grate
-  Stolen by mean-spirited crow
-  Adopted by school of fish

FIGURE 5

B.L. 1982—104

SEC. 104—DRINKABLE AREA (CAN)

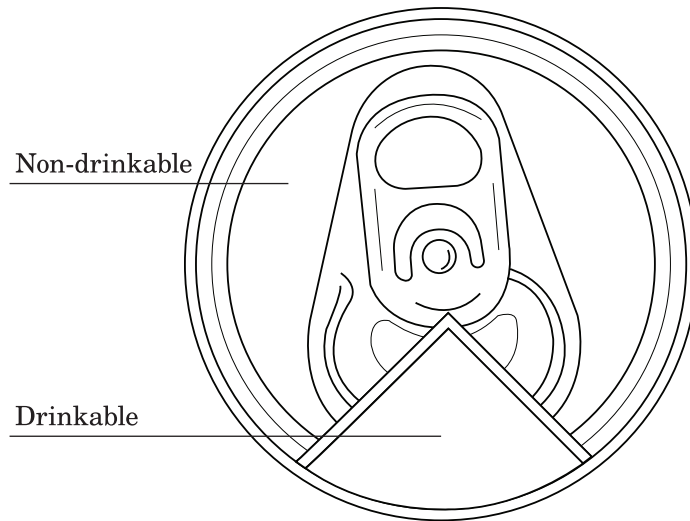

FIGURE 6

SEC. 105—DRINKABLE AREA (BOTTLE)

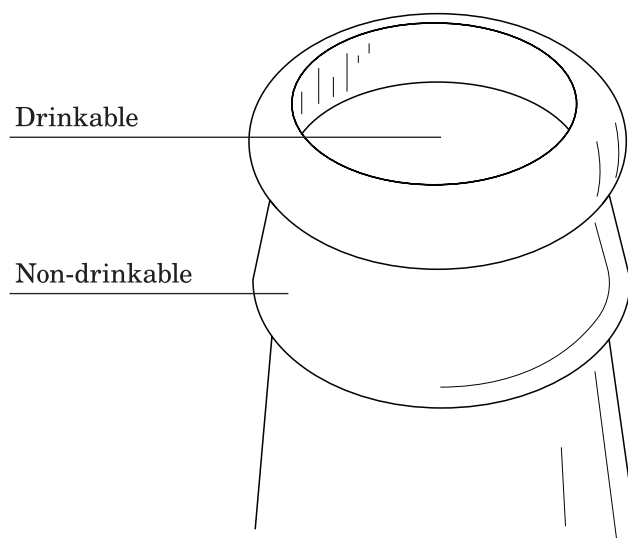

FIGURE 7

B.L. 1982—105

SEC. 106—MOST POPULAR SUMMER SLOGANS

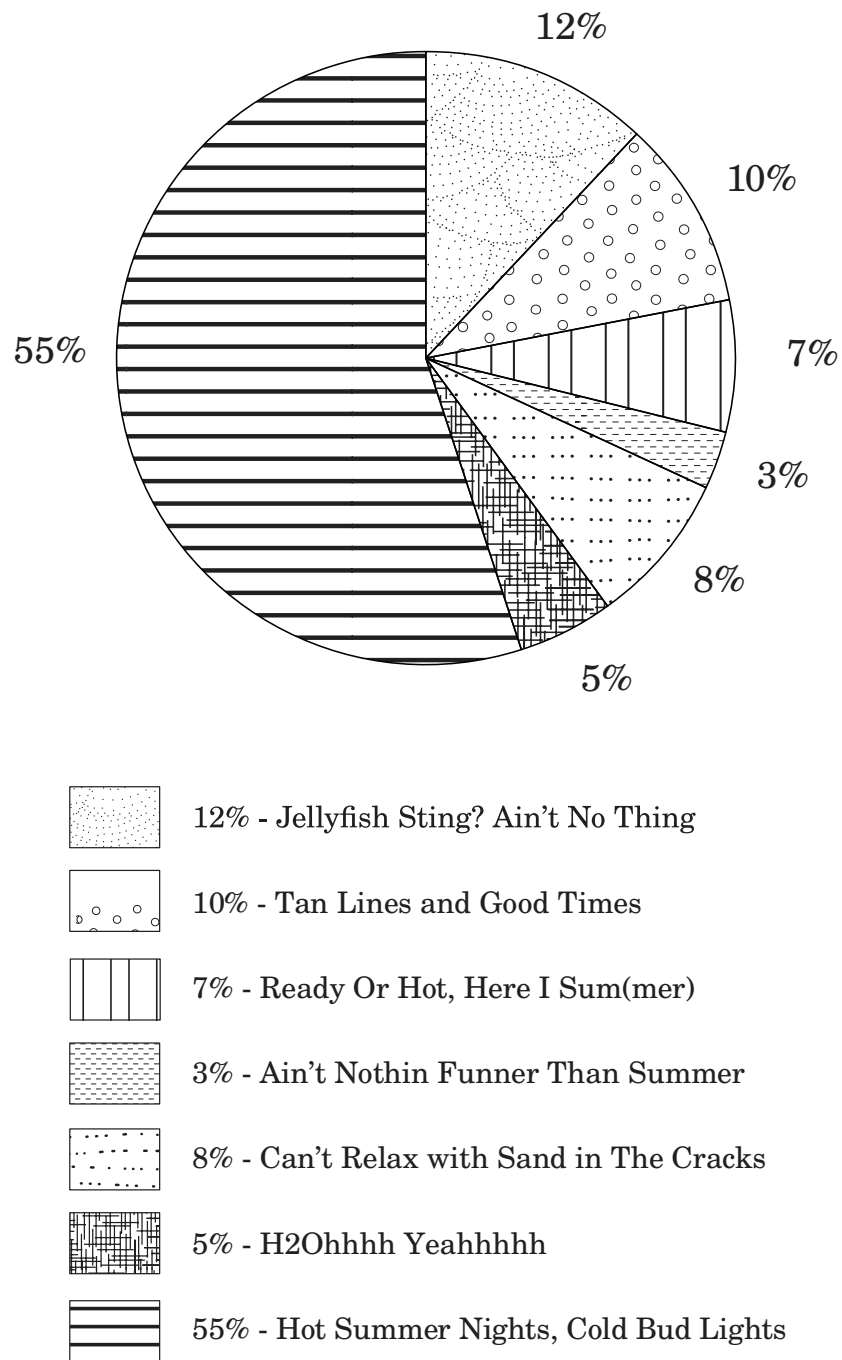

FIGURE 8

B.L. 1982—106

SEC. 107—PIE PIE CHART

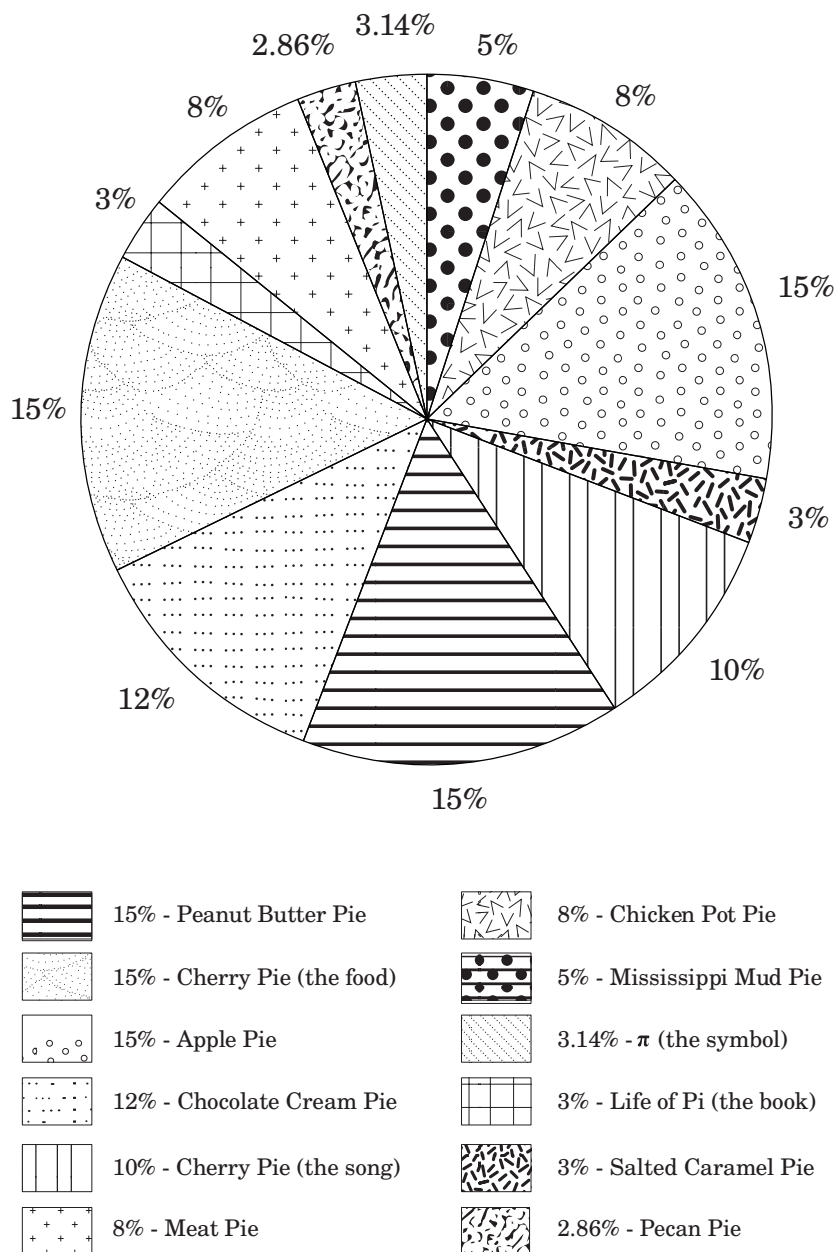

FIGURE 9

B.L. 1982—107

SEC. 108—BEST ‘SUN’S OUT, [BLANK’S] OUT’ PHRASES

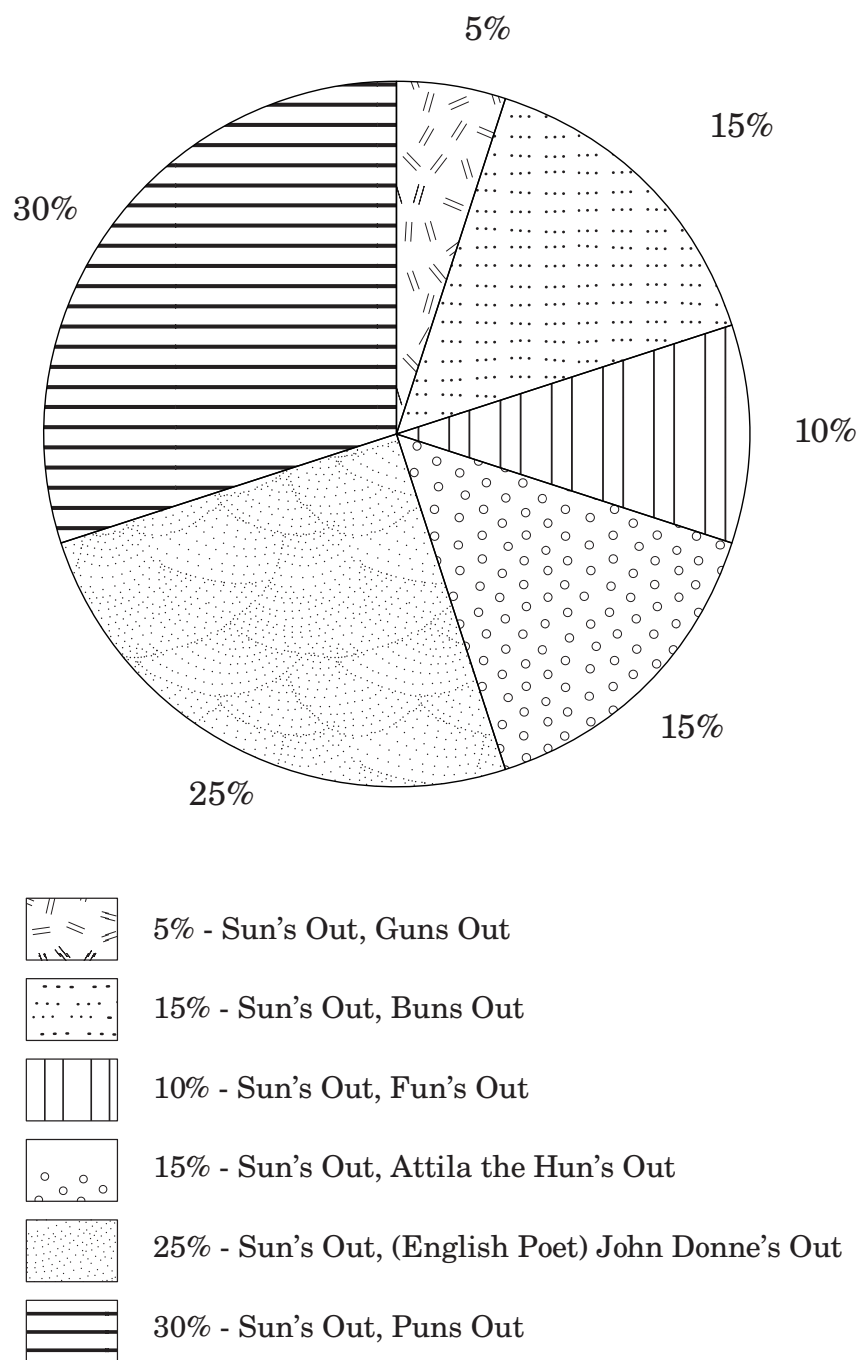
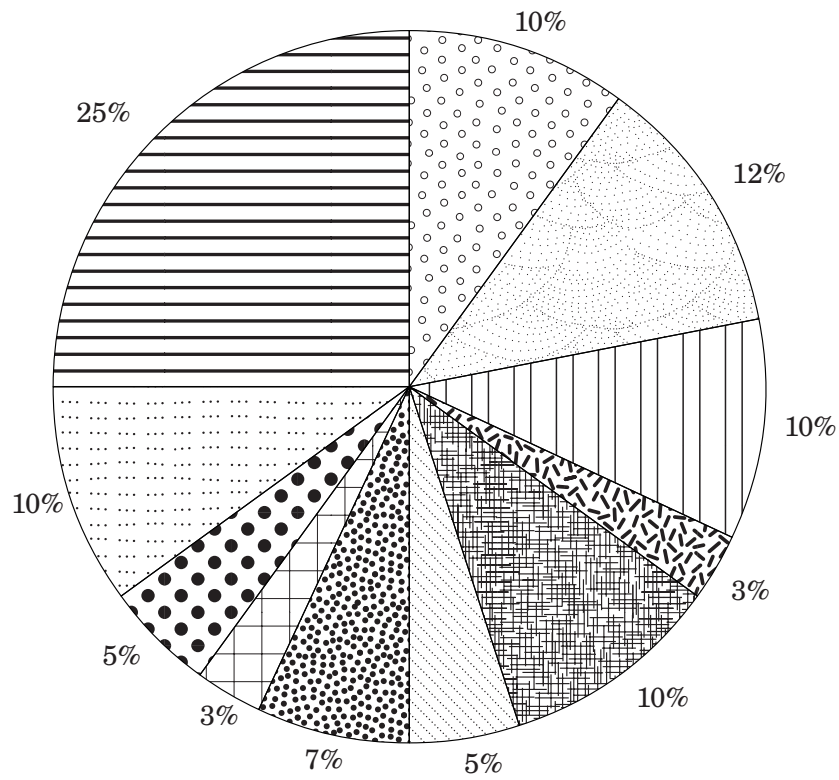

FIGURE 10

B.L. 1982—108

SEC. 109—BEST PLACE TO NAP DURING THE SUMMER













-  10% - Hammock
-  12% - Under beach umbrella
-  10% - Lounge chair in backyard
-  3% - Golf cart
-  10% - Couch while watching baseball
-  5% - Sec. 204, Row 10, Seat 3 while watching baseball
-  7% - Under your desk at work
-  3% - On top of your desk at work
-  5% - During one of those weird sleep studies you see advertised where they promise to pay you like \$80 a day while they creepily watch you sleep
-  10% - On your dog's ergonomic memory foam doggy bed while the dog is out for a walk
-  25% - Anywhere

FIGURE 11

B.L. 1982—109

SEC. 110—THE PERFECT SUMMER DAY

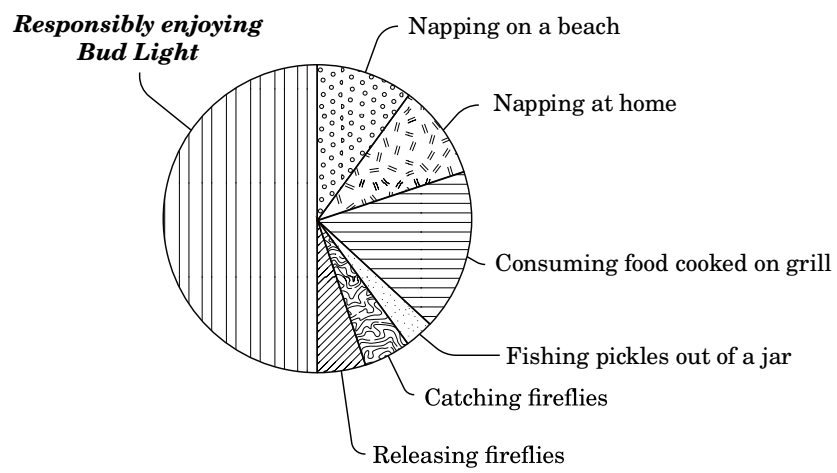

FIGURE 12

BUD LIGHT®